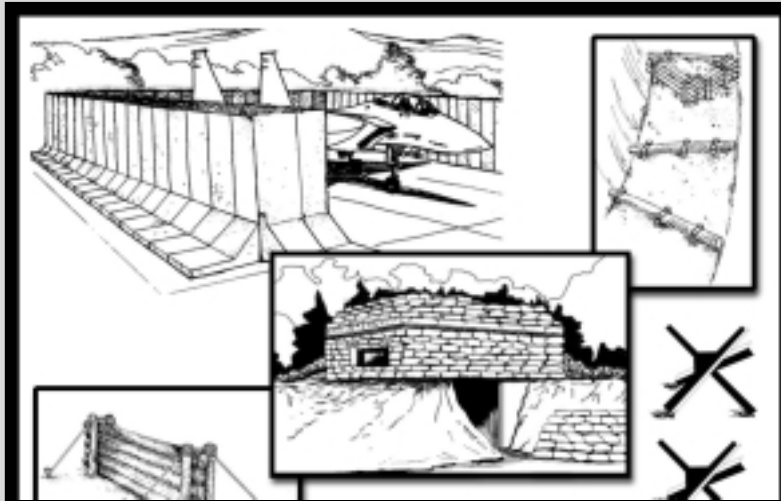




**AIR FORCE HANDBOOK 10-222, Volume 14
1 NOVEMBER 2000**

**GUIDE TO FIGHTING
POSITIONS, OBSTACLES,
AND REVETMENTS**



DEPARTMENT OF THE AIR FORCE

Report Documentation Page

Form Approved
OMB No. 0704-0188

Public reporting burden for the collection of information is estimated to average 1 hour per response, including the time for reviewing instructions, searching existing data sources, gathering and maintaining the data needed, and completing and reviewing the collection of information. Send comments regarding this burden estimate or any other aspect of this collection of information, including suggestions for reducing this burden, to Washington Headquarters Services, Directorate for Information Operations and Reports, 1215 Jefferson Davis Highway, Suite 1204, Arlington VA 22202-4302. Respondents should be aware that notwithstanding any other provision of law, no person shall be subject to a penalty for failing to comply with a collection of information if it does not display a currently valid OMB control number.

1. REPORT DATE 01 NOV 2000		2. REPORT TYPE N/A		3. DATES COVERED -	
4. TITLE AND SUBTITLE Guide To Fighting Positions, Obstacles, And Revetments - Air Force Handbook 10-222, Volume 14				5a. CONTRACT NUMBER	
				5b. GRANT NUMBER	
				5c. PROGRAM ELEMENT NUMBER	
6. AUTHOR(S)				5d. PROJECT NUMBER	
				5e. TASK NUMBER	
				5f. WORK UNIT NUMBER	
7. PERFORMING ORGANIZATION NAME(S) AND ADDRESS(ES) Secretary Of The Air Force Washington, DC				8. PERFORMING ORGANIZATION REPORT NUMBER	
9. SPONSORING/MONITORING AGENCY NAME(S) AND ADDRESS(ES)				10. SPONSOR/MONITOR'S ACRONYM(S)	
				11. SPONSOR/MONITOR'S REPORT NUMBER(S)	
12. DISTRIBUTION/AVAILABILITY STATEMENT Approved for public release, distribution unlimited					
13. SUPPLEMENTARY NOTES					
14. ABSTRACT					
15. SUBJECT TERMS					
16. SECURITY CLASSIFICATION OF:			17. LIMITATION OF ABSTRACT UU	18. NUMBER OF PAGES 109	19a. NAME OF RESPONSIBLE PERSON
a. REPORT unclassified	b. ABSTRACT unclassified	c. THIS PAGE unclassified			



GUIDE TO FIGHTING POSITIONS, OBSTACLES, AND REVETMENTS

NOTICE: This publication is available digitally on the SAF/AFDPO WWW site at: <http://afpubs.hq.af.mil>.

OPR: HQ AFCEA/CEXR (Lt Col Wayland Patterson)

Certified by: HQ AFCEA/CEX (Colonel Bruce F. Mc Connell)

Pages: 108/Distribution: F

Purpose: This handbook addresses the employment and construction of fighting positions, obstacles, and revetments by Civil Engineers. It provides basic concepts for use of fighting positions, obstacles, and revetments as expedient measures to defend against offensive forces and terrorist attack. It may be used at a deployed location, bare base, or at the home station. The defensive measures are primarily intended for protection against conventional weapons blast, fragmentation, and projectiles.

INTRODUCTION	5
GENERAL CONSTRUCTION REQUIREMENTS	8
PROTECTION REQUIREMENTS	12
Determining Protection Requirements	12
Specific Material Choices and Uses	16
Berm and Revetment Basic Design Considerations.....	20
Overhead Cover Considerations.....	28
CONSTRUCTION	34
Revetments	34
Obstacles.....	60
Fighting Positions.....	85

Figures

1. Historic Earthwork	5
2. Bracing Concepts	19
3. Containment Concepts	20
4. Sand Berm and Sandbag Revetment	21
5. Berm and Revetment Slopes	22
6. Blast Flow over Freestanding Berm	23
7. Blast Flow over Reinforced Berm	24
8. Precast Concrete Revetments/Retaining Walls	26
9. Sandbags Cut into a Slope.....	27
10. Blast Flow around Vertical Berms	28
11. Stringer Span Distance/On-Center Spacing for Fighting Positions.....	30
12. Burster Rock Layer over Hardened Position.....	33
13. Freestanding Berm Protecting a Fuel Bladder.....	35
14. Berm against a Building	35
15. Braced Face of Berm near Building	36
16. Freestanding Sloped Sandbag Revetment	37
17. Partially Braced Sandbag Revetment	38
18. Sandbags against a Structure	39
19. Sandbags Help Support Roof Covering.....	39
20. Soil-Cement Wall	40
21. Bitburg Revetments	41

22. Four-Meter Aircraft Revetments	42
23. Portable Precast Concrete Wall	42
24. Tire Revetment Walls	43
25. Plywood Walls	44
26. B-1 Bin Revetment	44
27. Dispersed Bin Revetments	45
28. Clustered Bin Revetments.....	46
29. Timber Revetment	47
30. Concrete Culvert Soil Bin	48
31. Concrete Chamber Soil Bin	48
32. 55-Gallon Drum Wall	49
33. Concrete Revetment Soil Bin	50
34. Rock Filled Gabion Walls	51
35. Sand Grid Revetment	52
36. Wire Frame, Fabric-Lined Containers/Concertainer Revetment	53
37. Berm against a Retaining Wall	54
38. Partially Braced Berm against a Retaining Wall	55
39. Berm against a Revetment.....	55
40. Landing Mat Shield	56
41. Log Wall Standoff	57
42. Corrugated Metal Wall Shield	58
43. Fencing Used as Standoff.....	60
44. Cratering Charge formed Landslide	62
45. Abatis on Forest Road.....	63
46. Typical Ditch Construction.....	64
47. Locating Log Hurdles	65
48. Locating Spoil Mounds.....	66
49. Log Hurdles	67
50. Staggering Placement of Hurdles	68
51. Log Cribs.....	69
52. Expedient Log Posts	70
53. Posts and Entanglements along Roadway	70
54. Placement of Staggered Posts	71
55. Steel Hedgehogs.....	72
56. Metal Caltrops	72
57. Concrete Cube and Cylinder.....	73
58. Concrete Tetrahedron and Dragons Tooth	73
59. Rubble Blocking Urban Streets	74
60. Tanglefoot Layout – Example	75
61. Concertina Wire Roadblock.....	76
62. Triple Concertina Fence	77
63. Stopping Capabilities of Obstacles	78
64. Straight Faced Curb	79
65. Cable Reinforced Chain Link Fences	80
66. Shallow Ditches and Low Berms and Moguls	81
67. Jersey Barrier	82
68. Placement of Roadway Obstructions	82
69. Barrier Spacing versus Automobile Speeds	83
70. Typical 4-inch Speed Hump	84
71. Hasty Natural Fighting Position	85
72. Hasty Augmented Fighting Position.....	85
73. Spacing of Bearing Support Beams for Overhead Cover.....	86
74. Facing Material Braced.....	87
75. Facing Material Held with Stakes	88

76. Staggered Stake Bracing of Pickets	89
77. Placement of Ground Shock Intercepting Trenches	90
78. Typical Grenade Sumps.....	91
79. 1-Person Fighting Position (Deliberate)	93
80. Straight 2-Person Fighting Position (Deliberate)	93
81. Extended 2-Person Fighting Position (Deliberate)	94
82. Machine Gun Fighting Position (Deliberate).....	94
83. Mortar Crew Fighting Position.....	95
84. LAW Fighting Position (Deliberate).....	96
85. Wood-Framed Fighting Position.....	97
86. Precast Concrete Slab Bunker.....	98

Tables.

1. Characteristics and Use of Fighting Positions, Obstacles, and Revetments	6
2. General Instruction of Fighting Positions.....	8
3. General Construction of Obstacles	9
4. General Construction of Revetments.....	10
5. Typical Weapons and Their Effects	13
6. Protection from Projectiles for Various Thicknesses of Material	13
7. Protection from Explosions (50 feet away) for Various Thicknesses of Material	15
8. Expedient Hardening Protection Measure for Assets	16
9. Relative Protection Levels Measure for Assets	16
10. Allowable Berm Heights for Conventional Wall Systems	25
11. Equivalent Sizes of Timber Compared with Dimensional Lumber	29
12. Maximum Span and On-Center Spacing for Stringers.....	30
13. Minimum Thickness of Sheathing over Stringers.....	31
14. Design Guidelines for Protection from Select Indirect-Fired Munitions (Contact Fuze)	31
15. Required Thickness of Cover for Protection against Indirect and Direct-Fired Weapons (Delayed Fuze)	32

Attachments

1. Arrangement Patterns for Revetments and Berms	99
2. Tests for Field Classification of Soil.....	102



THIS PAGE INTENTIONALLY LEFT BLANK.

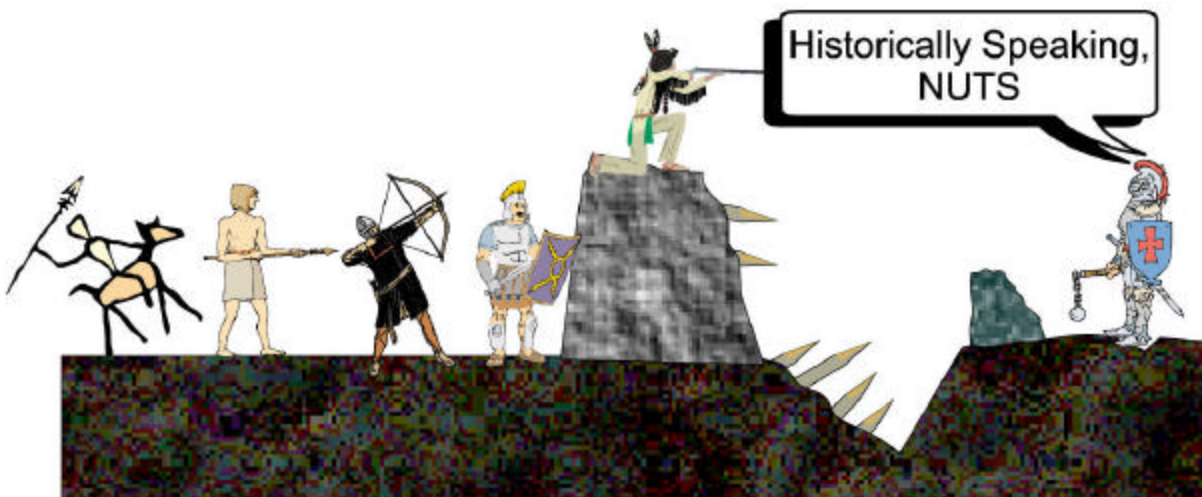


INTRODUCTION

This handbook addresses the employment and construction of fighting positions, obstacles, and revetments by Civil Engineers using **expedient measures** to defend against offensive forces or terrorist attack at a deployed location or bare base. Many of the measures may be used at home stations for expedient protection against terrorist attack. These defensive measures are intended for protection against blast, fragmentation, and projectiles, although some of the methods and materials may be effective against nuclear weapons. The users of this handbook are primarily Civil Engineers who may be required to provide expedient hardening measures and to construct or assist Security Forces in the hardening of fighting positions or constructing of obstacles. Contract construction for protection against terrorist attacks is not covered in this handbook; these methods are covered by AFH 10-222, Volume 3. The guidance in this handbook is based on information found in: AFPAM 10-219, Volume 2; AFH 10-222, Volume 3; AFJMAN 32-1034; Defense Special Weapons Agency Manual for Design and Analysis of Hardened Structures to Conventional Weapons Effects (DSWA DAHSCWEMAN-97); Joint Publication 315; QTPs 3E2X1C-26.2 and 3E3XC-37.5; and Army FMs 5-100, 5-103, 5-410, 7-8, and 90-7.

Background. *While the forces and weapons that military personnel must face have changed throughout history, the concepts of defense and the use of expedient fighting positions, obstacles, and revetments has not changed significantly. An earthwork was conceived as a defendable and protective barrier between the enemy and the defender. Basic in concept, the earthwork consisted of three parts: a ditch or trench, a short mound of spoil material (called a parapet) on the enemy side of the ditch to disrupt the flow and expose the enemy, and a much higher spoil mound on the defender's side (figure 1). The defender's spoil mound was usually much higher to provide protection for defense and movement. Often it was reinforced with wood, stone, and rock and fortified with staves and stakes to provide additional obstacles against rapid approach or to protect against larger weapons like the trebuchet, catapult, and cannon. Earthworks could be elaborate and several stories high, a long line of trenches along a ridge line, or even a hasty entrenchment for one single soldier to lie in prior to attacking the enemy. The earthwork has been used throughout the battlefields of history, whether the battlefield was American military, Native American, medieval European, ancient Roman, or prehistoric Egyptian. The concept of the earthwork carries over to modern fighting positions, obstacles, and revetments.*

Figure 1. Historic Earthwork.



Modern Application and Expedient Methods. Air Force personnel, who must contend with offensive forces and terrorist attacks while deployed at a bare base, should be familiar with the basic construction requirements for fighting positions, obstacles, and revetments. Air Force personnel at their home station, if they have to contend with

terrorist attacks, should also be familiar with obstacles and revetments. While Civil Engineers may not be the specific end user for many of these types of construction or structures, they may assist in construction of the facilities to protect aircraft and critical assets and facilities.

Fighting positions are generally the domain of the Security Forces. These positions are defensive in nature and are used to provide a fortified, **hidden** position from which to direct fire at offensive forces. They can also be used as an observation point or a fire control point to direct the fire from other positions. These defensive positions are typically sited to take advantage of natural terrain features, conceal the defender until the initial firing, and to provide a directed field of fire for the type of weapons United States Air Force (or Army or Marine) forces have at each position. Ideally the positions would provide overlapping fields of fire with adjacent fighting positions.

Obstacles are any obstructions designed or employed to disrupt, turn, impede, or block the movement of an opposing force. The obstacles can be natural, manmade, or a combination of both. Obstacles can be used to delay or redirect the advance of personnel, equipment, and vehicles of the opposing force. A **barrier** is a coordinated series of obstacles that can channel, direct, restrict, delay, and/or stop the movement of an opposing force. Barriers are most effective when they can be used to redirect the approach of opposing forces. They are also employed to prevent terrorist's vehicles from entering an installation or the area around a critical facility. Barriers should be developed so as not to provide a defensible fighting location for the opposing force when an attack occurs.

Revetments are raised structures that provide a level of protection against blast, splinters, shrapnel, and/or projectiles from bombs, rockets, grenades, small arms fire, or other weapon effects. A revetment may be as simple as a wall of sandbags or as elaborate as a hardened, reinforced concrete aircraft shelter.

Table 1 provides an overview of some basic characteristics, employment requirements, and resources associated with each system.

Table 1. Characteristics and Use of Fighting Positions, Obstacles, and Revetments.

What is the Threat?	Observability (i.e., can it be detected by approaching forces?)	Is it used for Defensive or Offensive Employment?	Is it Expedient or Planned Construction?	CE Resources Required
Fighting Positions				
Offensive forces	Very Low – intended to be hidden from view.	Both, but normally defensive for AF units; joint service or national support use both.	Both, but usually uses existing cover or expedient construction at start of operations; hardened positions may be built as time and location allow.	Security Forces provide for initial, expedient installation; CE personnel and equipment may be required for hardening, some overhead protection, and trench works.
Obstacles				
Offensive forces	Visible or Subtle (i.e., to let enemy know only after entering or surprise attack).	Both, but usually defensive for AF units.	Either use natural (existing) terrain or reinforce existing terrain with additional materials. Usually expedient at start of operations.	CE may be required for moving earth, rubble, forest, etc., or demolition.
Terrorists deployed or at peacetime location	Visible or Subtle (i.e., to let enemy know only after entering or surprise attack).	Defensive	May be both, but normally should be planned as a resource within base security plans.	CE may be required for fabrication, construction, and installation.

What is the Threat?	Observability (i.e., can it be detected by approaching forces?)	Is it used for Defensive or Offensive Employment?	Is it Expedient or Planned Construction?	CE Resources Required
Revetments				
Offensive forces	Medium to Low	Defensive	Both, especially if berms are used.	High CE involvement for construction and installation, but manpower efforts may be basewide for hasty.
Terrorists when deployed or at peacetime station.	Usually High	Defensive	Both but should be pre-planned at peacetime stations when possible.	High CE involvement for construction and installation; manpower efforts may be basewide.



GENERAL CONSTRUCTION REQUIREMENT

This chapter provides a preview on the use and construction for fighting positions, obstacles, and revetments. It introduces terminology that is used throughout the discussion for determining use, protection requirements, and construction.

Construction of Fighting Positions. Fighting positions protect personnel by providing cover through use of existing materials or construction of physical barriers or obstacles. They also provide concealment through positioning and proper camouflage. The position should not be readily identifiable by an opposing force. When possible, fighting positions should be sited in non-obvious places, such as behind natural cover, and should be easily camouflaged.

Basic criteria for fighting positions are detailed in Table 2 and below:

The positions should be armpit deep. The positions may require shallower ledges along the inside perimeter of the position to allow placing of weapons or bracing for aiming of weapons, depending on weapons employed.

Ensure that the position has stable construction:

- Brace/revet excavations in sandy or unstable soil and
- Check stabilization of wall bases.

Provide for grenade sumps; slope the interior ground/floor surface toward the sumps.

Inspect and test the position daily, after heavy rain, and after receiving weapons fire.

Maintain, repair, and improve positions as required.

Use proper material. Use it correctly.

NOTE: In sandy soil, vehicles should not be driven within 6 feet of the positions.

Table 2. General Construction of Fighting Positions.

Primary Class of Position	Specific Type of Construction/Feature	Description
Fighting Position (FP) General		
Hasty Natural	Personnel use existing holes/depressions, rocks, logs, etc., without digging.	Provides frontal protection and has at least 18 inches of depth. Concealment is a prime factor.
Hasty Augmented (also called Hasty Deliberate)	Personnel may use existing cover, but also requires additional digging in, normally with hand tools.	Provides frontal protection and 18 inches of depth. Arrange rocks, earth spoil from the hole, logs, rubble, etc., for additional protection and concealment. May use some sandbags.
Deliberate	When time permits, improve the hasty augmented position.	Dig in to armpit depth. Adds overhead cover and camouflage. Provides additional protection to the sides and rear, often with additional sandbags and spoil or selected fill materials.
Special Design	Built by CE and Security Forces when time, equipment, and personnel are available. Uses wood or steel framing, sandbags, berming, and earth cover. Can use concrete modular or precast	Provides additional protection from small arms and larger caliber weapons and munitions. Provides all around protection but may not provide full coverage of the area. More often used in areas where natural cover or

Primary Class of Position	Specific Type of Construction/Feature	Description
	concrete revetment sections for additional protection.	protection is lacking.
Reinforced Bunker	When time, equipment, and personnel permit, use reinforced concrete and components, concrete or earth filled revetments, and/or heavy gauge or structural steel members and sheeting. Used for deployment of larger forces for longer stays in the field.	Requires longer construction times, prior planning for manufacturing, or pre-positioning. Normally not a well concealed position. Relies on offensive forces not being able to penetrate the structure with available munitions. Provides all around protection but may not provide full coverage of the area.
1-person FP		
		Allows defender to either cover the front or the front oblique areas around the frontal protection.
2-person FP		
		Allows defenders to cover the front and front oblique areas; normally allows coverage up to an adjacent FP.
3-person FP		
		Usually used by machine gunners, it provides front and side coverage and room for spotters. Useful also for keeping additional equipment and support of longer-term stays in the field.

While fighting positions are usually employed by the Security Forces for base defense, Civil Engineers may also use hasty positions and deliberate positions for defense of resources.

Use or Construction of Obstacles. Basic criteria and descriptions of obstacles are provided in Table 3.

Table 3. General Construction of Obstacles.

Primary Class of Obstacle	Specific Type of Construction/Feature	Description
Obstacles used against Offensive forces		
Existing materials in a natural setting	Terrain Features	Steep slopes; Escarpments; Ravines, gullies, and ditches; Rivers, streams, and canals; Swamps and marshes; Snow; and Trees
Existing construction	Built-up Areas	Buildings (usually large) in cities with narrow streets
Reinforcing	Extends or ties together existing obstacles	Mines; Abatis (directionally felled tree mats along roadways or trails); Craters; Ditches; Cribs; Hurdles; Posts; Steel Hedgehogs; Caltrops (steel tetrahedrons); Concrete objects (cubes, cylinders, tetrahedrons, dragon's teeth); Rubble; Junked vehicles and equipment; and wire entanglements
Obstacles used against Terrorists		
Passive	Within local capabilities	High (8-12") vertical curbs; Fencing; Filled posts; Vegetation; Concrete barriers (Jersey barriers and reinforced planters); Concrete retaining walls; Half buried equipment tires; Shallow ditches; Soil and sandbagged berms; Filled 55-gallon drums; and Heavy equipment
Active	Vehicle (may not be within local capabilities except with	Plate and drum type rising (pavement) barriers; Portable barriers; Crash beams;

Primary Class of Obstacle	Specific Type of Construction/Feature	Description
	contract support)	Sliding crash gates; and Cable and beam barriers
	Vehicle Speed Control	S-curves; 90-degree bends; Traffic circles; Speed bumps; Concrete obstacles; and Removable steel posts

For deployments to a Theater of Operations, the use of obstacles against offensive forces may be on a broader scale than required by just Air Force Security Forces. Security Forces normally defend the immediate area inside a base's tactical area of responsibility (TAOR) boundary. When **only** Air Force personnel are responsible for base defense, then Security Forces and Civil Engineers should work together to use obstacles for operational employment.

The use of obstacles against offensive forces outside the TAOR normally falls within Joint Service (or even multi-national) doctrine for employment of barriers, obstacles, and minefields. Joint Service doctrine is much broader in scope and covers both tactical and strategic employment. The Joint Force Commander is responsible to ensure that employment of barriers, obstacles, and minefields follow international law and US policy. When establishing the TAOR and it is known that there will be joint service involvement, check for any joint plan requirements to avoid placing the wrong obstacles within joint maneuver areas. For joint force operations to support the theater operations plan, the use of obstacles may require installation by Air Force, Army, and other joint service engineering or security forces.

Construction of Revetments. Table 4 lists the three basic types of **expedient hardening** methods, soil, concrete modular revetments, and bin revetments; these methods are temporary or semi-permanent in nature. Variations of these three types of construction normally occur through mixing or augmenting one type of construction with another type to increase levels of protection. Soil berms and sandbags, soil cement, and sandbag with soil-cement structures are similar in the use of soil or sand as the major component for construction; they are grouped together for that reason. Note: While soil type soil berms do not need a reinforced base, the sandbag, soil cement, and sandbag with soil cement type structures may require a reinforced base.

NOTE: Sandbag, soil cement, and sandbag with soil cement type structures may require a reinforced base.

Table 4. General Construction of Revetments.

Primary Type of Construction	Specific Type of Construction	Source of Major Items/Components
Soil		
	Soil	Dig it, have it delivered, or haul it to site
	Sandbag	Pre-position bags and possibly fill
	Soil Cement	Pre-position or local purchase cement
	Sandbag with Soil Cement	Pre-position bags and fill and pre-position or local purchase cement
Concrete Modular		
	Bitburg	Must be manufactured and pre-positioned prior to need
	4-meter aircraft	Must be manufactured and pre-positioned prior to need
	Precast panel	Must be manufactured and pre-positioned prior to need
	Sacrificial Panel	Must be manufactured and pre-positioned prior to need
Bin		
	Log (timber)	Chop or saw

Primary Type of Construction	Specific Type of Construction	Source of Major Items/Components
	Lumber	Pre-position or local purchase
	Plywood	Pre-position or local purchase
	55 Gallon drum	Surplus or local purchase
	Concrete culvert	Local purchase
	Concrete manhole liner	Local purchase
	Sand grid ¹	Pre-position or local purchase
	Gabions ²	Pre-position or local purchase
	Fabric lined gabion/ Concertainer ³	Pre-position
	Steel ARMCO ⁴	Tear down, relocate parts, and reassemble
	Steel A-1 ⁵	Pre-position
	Steel B-1 ⁶	Pre-position

Notes:

¹ Accordion style welded-plastic, egg crate type materials filled with sand. Many layers of horizontal grid units stacked upon each other to provide height. Can be partially stabilized with stakes driven between layers.

² Wire mesh cages that are filled with rock. Units stacked side-by-side, end-to-end, and upon each other. Can be wired together for greater stability.

³ A very large unfolded gabion like cage with welded-plastic or geotextile material to allow use of sand and soil as fill. Units stacked side-by-side, end-to-end, and upon each other. Can be wired together for greater stability.

⁴ An out of production, bolted-connection, steel bin revetment that may still be present at some locations.

⁵ A pin-connection, lightweight steel bin revetment system that has a maximum height of 12 feet.

⁶ A pin-connection, lightweight steel bin revetment system that has a maximum height of 16 feet.



PROTECTION REQUIREMENTS

This chapter provides an overview on what should be considered to determine:

- Protection requirements (to defeat some weapons types and effects),
- Specific materials and techniques that can be used to defeat or mitigate weapons effects, and
- Basic design requirements and considerations for revetments, berms, and overhead cover.

DETERMINING PROTECTION REQUIREMENTS.

Civil Engineers and Security Forces need to assess the threat and the vulnerability to determine the requirements for expedient hardening of facilities, equipment, and fighting positions. In many cases the hardening is through the use of revetments and overhead cover.

A **threat analysis** will determine what type of forces must be defended against, which in turn will help determine the level(s) of protection required for facilities. The **situation** at your location will also dictate the amount of protection and the type of construction used to achieve it. The situation includes:

- Number of resources to be protected,
- Size of the protective structure,
- Time, materials, personnel, and equipment available to construct the structures,
- Duration of use, and

Natural conditions (soil types, topography, weather (especially rainfall amounts), vegetation, drainage, etc.).

The **specific weapons** you are required to defend against is a third consideration in determining protection requirements. There are basically two types of conventional weapons to consider, **direct-fired** and **indirect-fired**. The two systems vary as to their effects; it is important to know which weapons to defend against when considering the amount, design, and placement of revetments and cover.

Direct-fired weapons fire a projectile that is designed to strike a target and penetrate the exterior protection. Direct-fired weapons are normally highly accurate, low trajectory weapons (i.e., tanks, antitank guns, automatic cannons, and heavy caliber machine guns) that fire projectiles that would fall into several classes of rounds:

- Chemical or kinetic energy (high velocity and mass) projectiles,
- Ball or tracer rounds (relatively small caliber weapons from pistols, rifles, and light machine guns),
- Armor piercing rounds, or
- High explosive (HE) and HE shaped charges (antitank rockets, recoilless rifle rounds) to achieve penetration.

Indirect-fired weapons are mortars, artillery shells, rockets, and bombs; they rely on blast and fragmentation to affect the target. They have a higher trajectory and steeper angle of drop.

Table 5 presents some typical weapons and their effects.

Table 5. Typical Weapons and Their Effects.

Weapons Type	Typical Effects
PROJECTILES <ul style="list-style-type: none"> • Small Arms and Aircraft Cannons • Direct- and Indirect-Fired Weapons • Grenades 	<ul style="list-style-type: none"> • Projectile penetration and Spall • Airblast, fragment penetration, projectile penetration, and spall • Fragment penetration
BOMBS <ul style="list-style-type: none"> • High-Explosive (HE) • Fire and Incendiary • Dispenser and Cluster 	<ul style="list-style-type: none"> • Airblast, fragment penetration, groundshock, cratering, and ejecta • Fire • Fragment penetration
ROCKETS AND MISSILES <ul style="list-style-type: none"> • Tactical Weapons • Battlefield Support 	<ul style="list-style-type: none"> • Projectile penetration and airblast • Airblast, fragment penetration, groundshock, cratering, and ejecta
SPECIAL PURPOSE WEAPONS <ul style="list-style-type: none"> • Fuel-Air Munitions • Incendiary • Demolition Charges 	<ul style="list-style-type: none"> • Airblast • Intense heat, noxious gas, and oxygen deprivation • In-structure shock, airblast, cratering, and groundshock

Based on the weapons, threat, and situation, Security Forces and Civil Engineers can determine the type and size of hardening protection that will be required and can be constructed within the available resources. The normal situation is that **expedient hardening** will be required for bare base facilities and equipment. When available, common materials can be used for protection of facilities and equipment. Expedient hardening can be used for an existing base where permanent structures are involved. However, the ideal situation is to incorporate hardening into the permanent structure during initial construction, such that walls, roofs, wall openings, floor, and electrical, plumbing, and mechanical systems are protected from the worst case weapons effects.

Table 6 lists some of the materials that will provide acceptable protection from projectiles (based on the thickness of the materials). In some cases the materials listed provide a relative thickness without describing the method to contain the materials.

Table 6. Protection from Projectiles for Various Thicknesses of Material.

Material (Thickness in inches)	Small Caliber Machine Gun (7.62mm) fired at 100 yards ¹	Antitank Rifle (76-mm) fired from 100 yards	20-mm Anti-tank fired from 200 yards	37-mm Anti-tank fired from 400 yards	50-mm Anti-tank fired from 400 yards	75-mm Direct-fired from 500 to 1,000 yards	Remarks
Solid walls ²							
Brick masonry	18	24	30	60	N.R.	N.R.	
Concrete, not Reinforced ³	12	18	24	42	48	54	Plain formed concrete walls
Concrete, Reinforced	6	12	18	36	42	48	Reinforced with steel
Stone masonry	12	18	30	42	54	60	Guidance only
Timber	36	60	N.R.	N.R.	N.R.	N.R.	Guidance only
Lumber	24	36	48	N.R.	N.R.	N.R.	Guidance only

Material (Thickness in inches)	Small Caliber Machine Gun (7.62mm) fired at 100 yards ¹	Antitank Rifle (76-mm) fired from 100 yards	20-mm Anti-tank fired from 200 yards	37-mm Anti-tank fired from 400 yards	50-mm Anti-tank fired from 400 yards	75-mm Direct-fired from 500 to 1,000 yards	Remarks
Walls of loose material between boards:²							
Brick rubble	12	24	30	60	70	N.R.	Add 100% to thickness when wet
Clay, dry	36	48	N.R.	N.R.	N.R.	N.R.	
Gravel and small crushed rock	12	24	30	60	70	N.R.	
Loam, dry	24	36	48	N.R.	N.R.	N.R.	Add 50% to thickness when wet
Sand, dry	12	24	30	60	70	N.R.	Add 100% to thickness when wet
Sandbags filled with:							
Brick rubble	20	30	30	60	70	N.R.	Add 50% to thickness when wet
Clay, dry	40	60	N.R.	N.R.	N.R.	N.R.	
Gravel and small crushed rock	20	30	30	60	70	N.R.	
Loam, dry	30	50	60	N.R.	N.R.	N.R.	Add 50% to thickness when wet
Sand, dry	20	30	30	60	70	N.R.	Add 100% to thickness when wet
Parapets of:							
Clay	42	60	N.R.	N.R.	N.R.	N.R.	Add 100% to thickness when wet
Loam	36	48	60	N.R.	N.R.	N.R.	Add 50% to thickness when wet
Sand	24	36	48	N.R.	N.R.	N.R.	Add 100% to thickness when wet
Snow and Ice:							
Frozen snow	80	80	N.R.	N.R.	N.R.	N.R.	
Frozen soil	24	24	N.R.	N.R.	N.R.	N.R.	
Ice-crete (ice + aggregate)	18	18	N.R.	N.R.	N.R.	N.R.	
Tamped snow	72	72	N.R.	N.R.	N.R.	N.R.	
Unpacked snow	180	180	N.R.	N.R.	N.R.	N.R.	

Material (Thickness in inches)	Small Caliber Machine Gun (7.62mm) fired at 100 yards ¹	Antitank Rifle (76-mm) fired from 100 yards	20-mm Anti-tank fired from 200 yards	37-mm Anti-tank fired from 400 yards	50-mm Anti-tank fired from 400 yards	75-mm Direct-fired from 500 to 1,000 yards	Remarks
NOTES: ¹ One burst of five shots. ² Thicknesses to nearest 1/2 ft. ³ 3,000 psi concrete. NOTE: Except where indicated, protective thicknesses are for a single shot only. Where weapons place five or six direct fire projectiles in the same area, the required protective thickness is approximately twice that indicated. N.R. = The material is not recommended for use.							

Note: As used throughout all text herein, *timber* refers to trees trimmed of branches and left as logs, while *lumber* (also called dimensioned lumber) is processed wood that has been sawn and dried.

Table 7 lists some of the materials that will provide acceptable protection from blast and fragmentation/shrapnel effects (based on the thickness of the materials).

Table 7. Protection from Explosions (50 feet away) for Various Thicknesses of Material.

Material (thickness in inches)	Mortar		Rocket	HE Shell		Bomb			
	82- mm	120- mm	122- mm	122- mm	152- mm	100- lbs	250- lbs	500- lbs	1,000- lbs
Solid walls:									
Brick masonry	4	6	6	6	8	8	10	13	17
Concrete, not reinforced	4	5	5	5	6	8	10	15	18
Concrete, reinforced	3	4	4	4	5	7	9	12	15
Lumber	8	12	12	12	14	15	18	24	30
Walls of loose material between boards:									
Brick rubble	9	12	12	12	12	18	24	28	30
Soil*	12	12	12	12	16	24	30	N.R.	N.R.
Gravel, small crushed stone	9	12	12	12	12	18	24	28	30
Sandbags filled with:									
Brick rubble	10	18	18	18	20	20	20	30	40
Clay, dry*	10	18	18	18	20	30	40	40	50
Gravel, small stones, soil	10	18	18	18	20	20	20	30	40
Sand, dry*	8	16	16	16	18	30	30	40	40
Loose parapets of									
Clay, dry*	12	20	20	20	30	36	48	60	N.R.
Sand, dry*	10	18	18	18	24	24	36	36	48
Snow									
Tamped	60	60	60	60	60	N.R.	N.R.	N.R.	N.R.
Unpacked	60	60	60	60	60	N.R.	N.R.	N.R.	N.R.

* Double the thickness when material is wet.
N.R. = The material is not recommended.

An evaluation of protection values is relative. Variations in weapon trajectory, fusing, penetration, net explosive weight, distance from the blast, height of the blast, and construction materials create some uncertainty in all determinations of weapons effects. Table 8 provides a quick comparison of expedient hardening methods and where they can be used to provide adequate protection of structures and assets. Table 9 provides a relative performance measure for various levels of protection based on testing of some common weapons and methods of protection. It can be used when identifying the adequacy of initial methods for protection of structures and assets.

Table 8. Expedient Hardening Protection Measure for Assets.

Hardening Method	Will the method provide protection for:		
	Vertical Wall	Overhead	Exposed Asset
Soil berms	Yes	Yes ¹	Yes ²
Sandbags	Yes	Yes	Yes
Sand grids	Yes (vertical)	Yes (horizontal)	Yes (vertical)
Concrete modular revetments	Yes	No	Yes
Bin revetments (vertical)	Yes	No	Yes
Sacrificial Panels	Yes	Yes	No

¹ Loose soil cover with parapet wall confinement.
² As a freestanding structure or in conjunction with a modular revetment

Table 9. Relative Protection Levels Measure for Assets.

Hardening Method	Relative Level of Protection for the following events:				
	Near Miss GP Bomb	Direct Hit Small HE (<15 lbs)	Shaped Charge	Ballistic Impact Up to 50 Cal.	Multiple Attacks
Soil berms	HIGH	HIGH	HIGH	HIGH	HIGH
Sandbags	HIGH	HIGH	MED	HIGH	MED
Sand grids	HIGH	HIGH	MED	HIGH	MED
Concrete modular revetments	MED	MED	LOW	MED	LOW
Bin revetments	HIGH	HIGH	MED	HIGH	MED
Sacrificial panels	MED	MED	LOW	MED	NONE

SPECIFIC MATERIAL CHOICES AND USES.

A hasty fighting position is a position where the defender uses natural cover and protection for a hidden defensive location. A hasty fighting position usually uses some natural materials for protection, such as a mound of soil, a tree, a fallen log, or a boulder. The materials used to construct fighting positions, obstacles, or revetments are quite similar. Some of the materials have characteristics and limitations as listed below, which may affect the choices of construction techniques, fill material, retaining or containing materials, construction times, and construction equipment and tools.

As shown in the previous tables, various thicknesses of materials provide different levels of protection based on the weapon and the materials. Materials can be used in three ways: as **shielding**, as a **structural component**, or in **combination**. Shielding is primarily the exterior construction that protects personnel and resources against penetration by projectiles, fragments, fire, or chemical munitions. Structural components are normally the materials used to reinforce a structure to withstand the blast.

Common Shielding Materials.

Soil: Soil is the most commonly available material. It is effective when used for protection against direct fire, indirect fire fragmentation, and blast. Soil structures of large mass prevent transmission of most projectiles under 75mm. Denser soils are more effective in stopping penetration, but penetration increases with the moisture content of the soil. For soils of the same density, coarse-grained soils provide better protection against penetration than do fine-grained soils. Soils should be protected against moisture (saturation) and sandy soils are superior to silt, clay, or silty-clay soils.

Steel: Steel is the most commonly used material for protections against direct fire and indirect fire fragmentation. Steel can provide a high value of protection against penetration and often deforms or deflects projectiles that are penetrating.

Concrete: Steel reinforced concrete can provide excellent protection against direct fire and indirect fire fragmentation. However, it is subject to failure when an explosive shell hits nearby, fragments crack the concrete, and then the blast hits the concrete. The failure may be the collapse of the structure or (from the inside of the wall) the dislodging of chunks of concrete and concrete spall projectiles.

Rock: Rock can be effective against direct fire and indirect fire fragmentation. However, due to the joints and fractures that are present or develop in rock, it can be weakened with multiple hits. Hard rock can be used to deform, stop, or deflect projectiles. Small rock and gravel in mass can be used like soil and is less susceptible to moisture. A downside in the use of rock is that it can become a projectile when broken loose by impact or blast.

Brick and Masonry: Brick and masonry have the general characteristics of rock for protecting against direct fire and indirect fire fragmentation.

Snow and Ice: Snow and ice may be the only material available at some locations. They may be effective against small caliber weapons and nearby blast when used in mass or in combination with frozen soil and/or ice chunks.

Wood: Wood in general has limited value as a direct means of protection from projectiles or fragmentation due to its low density. Whether using lumber, plywood, wood sheathing, or timber, great thicknesses of wood are required to stop small caliber machine gun and anti-tank weapons.

Other materials: Landing mats, aircraft cargo pallets, steel shipping boxes, culverts, and drums all have limited value as a direct means of protection from projectiles or fragmentation.

Common Structural Materials. While the walls, roof, and floor may provide some degree of protection on their own, they normally require some degree of structural hardening to withstand the weapons effects of blast and ground shock. Typically the walls and roof can support some shielding materials, while the floor may be used as a part of the bracing system for the walls and roof. Increasing the size and strength of the structural materials may make the walls and roof act as their own shielding. Typical structural materials are steel plates and shapes, steel pipe, reinforced concrete, and wood sheathing and lumber.

Combination of Materials. The most effective and efficient use of materials is achieved by using structural materials with shielding materials. By using a combination of materials for reinforcing walls and roofs to support shielding materials, damage effects can be decreased for both blast and projectiles/ fragmentation. Just as in the earthworks of old, a protective wall of earth or other bulk shielding material is a good defense against even modern conventional weapons when the *earthworks* can be contained, shaped, and reinforced. Illustrated below are the several ways to combine materials:

Bracing: This construction technique uses a structural material to support a mass of earth or other loose shielding material (figure 2). Common bracing situations occur when a wall holds back soil from a berm,

brace earth embankments in a trench, or acts as a horizontal roof structure. This technique of using a bracing material as part of a retaining wall to hold back earth or a berm is also called **revetting**.

Containment. This construction uses a structural material or a system made from structural materials to contain loose shielding materials. The type of containment structure varies and may be:

- Rigid metal such as a bin revetment,

- Sheathing material (wood, metal, or plastic) such as a wood wall,

- Flexible wire and/or fabric structure such as a Concertainer wire-fabric system,

- Rigid structural container such as precast concrete utility manholes, or

- Rigid containers such as filled 55-gallon drums (figure 3).

Figure 2. Bracing Concepts.

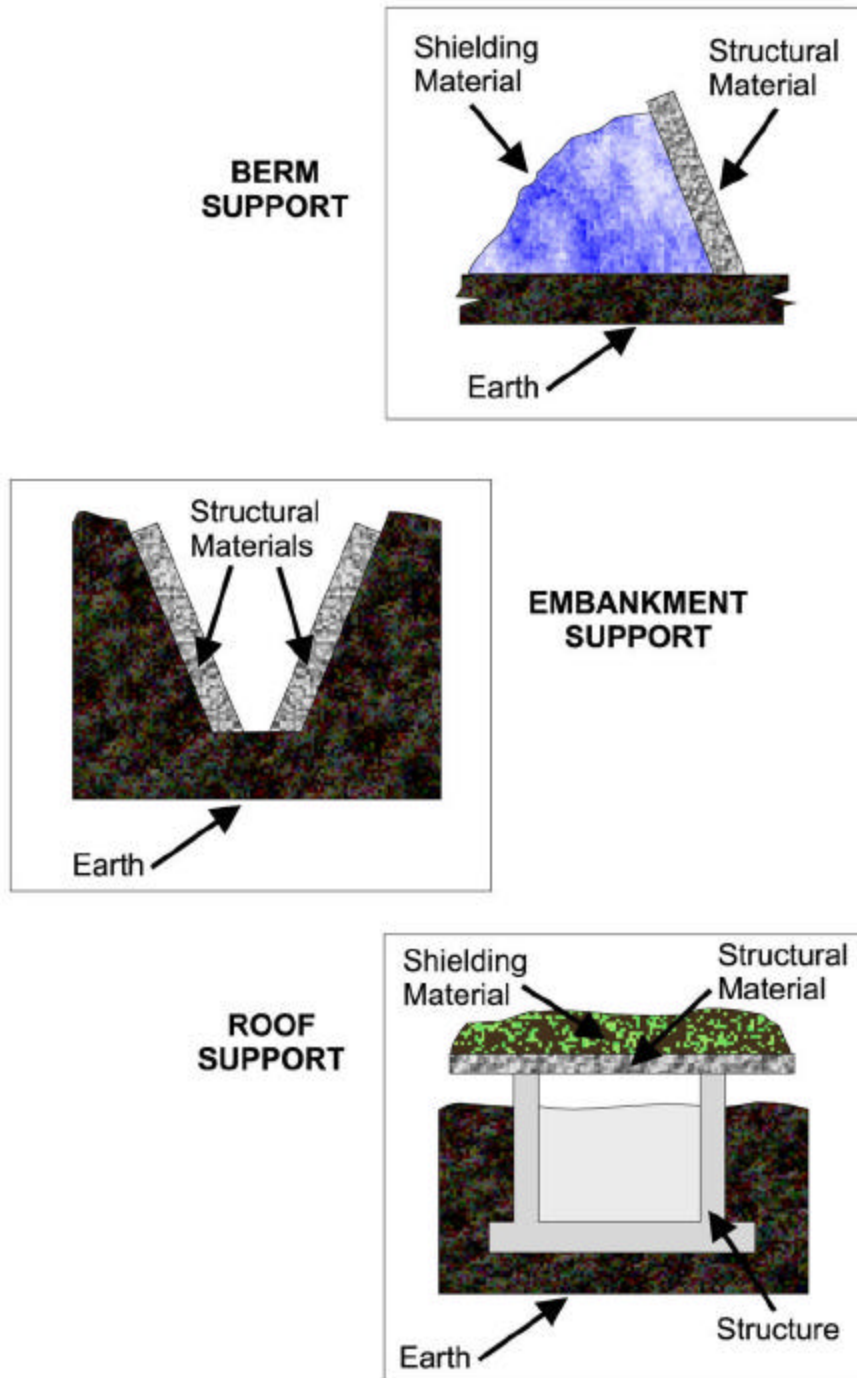
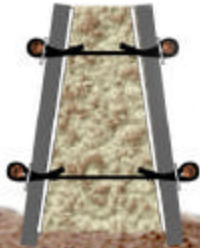
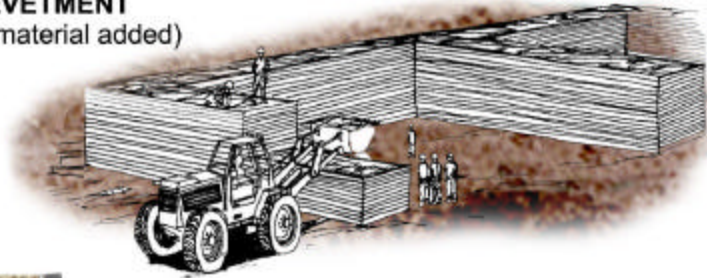


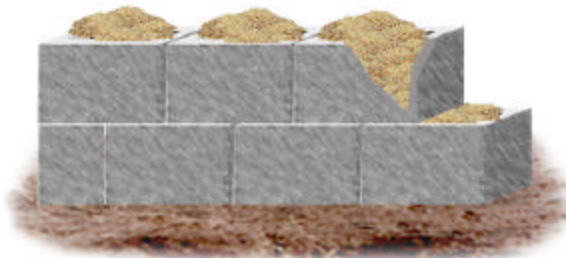
Figure 3. Containment Concepts.

BIN REVETMENT
(without fill material added)



WOOD REVETMENT
(filled with soil and fill;
shown with plywood sheathing,
4 x 4 posts, and tie wires)

**CONCERTAINER
SYSTEM**



**PRECAST CONCRETE
UTILITY MANHOLE**
(filled with sand;
shown with cutout section)

**55 GALLON DRUM
REVETMENT**
(filled with sand)



BERM AND REVETMENT BASIC DESIGN CONSIDERATIONS.

The use of berms and sandbag revetments is one of the most commonly used techniques for expedient protection. The proper placement of a berm or revetment in front of an object can deflect or stop fragmentation and direct-fired projectiles. These structures may also be used to provide blast protection. It is important to recognize key concepts

for the use of berms and revetments. See Attachment 1 for basic arrangement patterns for revetments and berms. The following are basic design considerations.

Shielding Thickness. The design thickness of soil shielding is measured at the top of the berm or the revetment. The thickness is chosen to be sufficient to provide a designed measure of protection to withstand blast pressure and stop or slow down a projectile or fragment. If the required thickness for horizontal protection is determined to be 32 inches, then the 32 inches of thickness is measure at the crest of the berm (i.e., the top of the berm). The same is true for a revetment. This is shown in figure 4, where a sand berm and a sandbag revetment provide the same degree of initial penetration. For practical purposes of construction and maintenance, the minimum thickness at the crest of the berm should be between 2 to 3 feet.

There is much more physical mass of uncompacted soil or loose sand required for a berm than a sandbag revetment. This is due to the slope of the sides of the berm. When the berm is composed of loose materials, the sides of the berm will slope at an angle about equal to the soil's internal angle of friction between particles or to the angle of repose. For cohesionless soils such as sand, **the slope (i.e., the ratio expressed as distance vertical to distance horizontal)** is normally between 1 to 1 (1:1) and 1 to 2 (1:2). For a free standing sandbag revetment that will be taller than it is wide, then the sandbags should also be sloped at between 4:1 and 5:1 for any structure over about 2 feet high. For compacted or cohesive soils such as those containing clay, the slope may be steeper depending on the moisture content of the soil, but normally should not exceed 3:1 (figure 5). No matter the height of the berm or the width at the base of a freestanding berm, the berm protection value is dictated by the minimum width of the berm at the crest. Remember that when a berm is used to contain fuel (such as at a fuel storage area for aircraft or base generator plants), it must be designed to meet the requirements for both fuel containment and protection from blast and/or shrapnel.

Figure 4. Sand Berm and Sandbag Revetment.

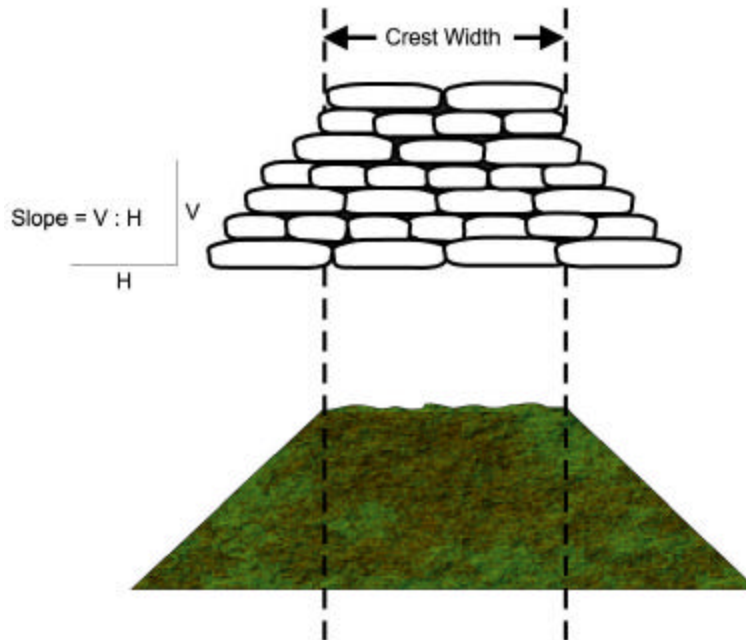
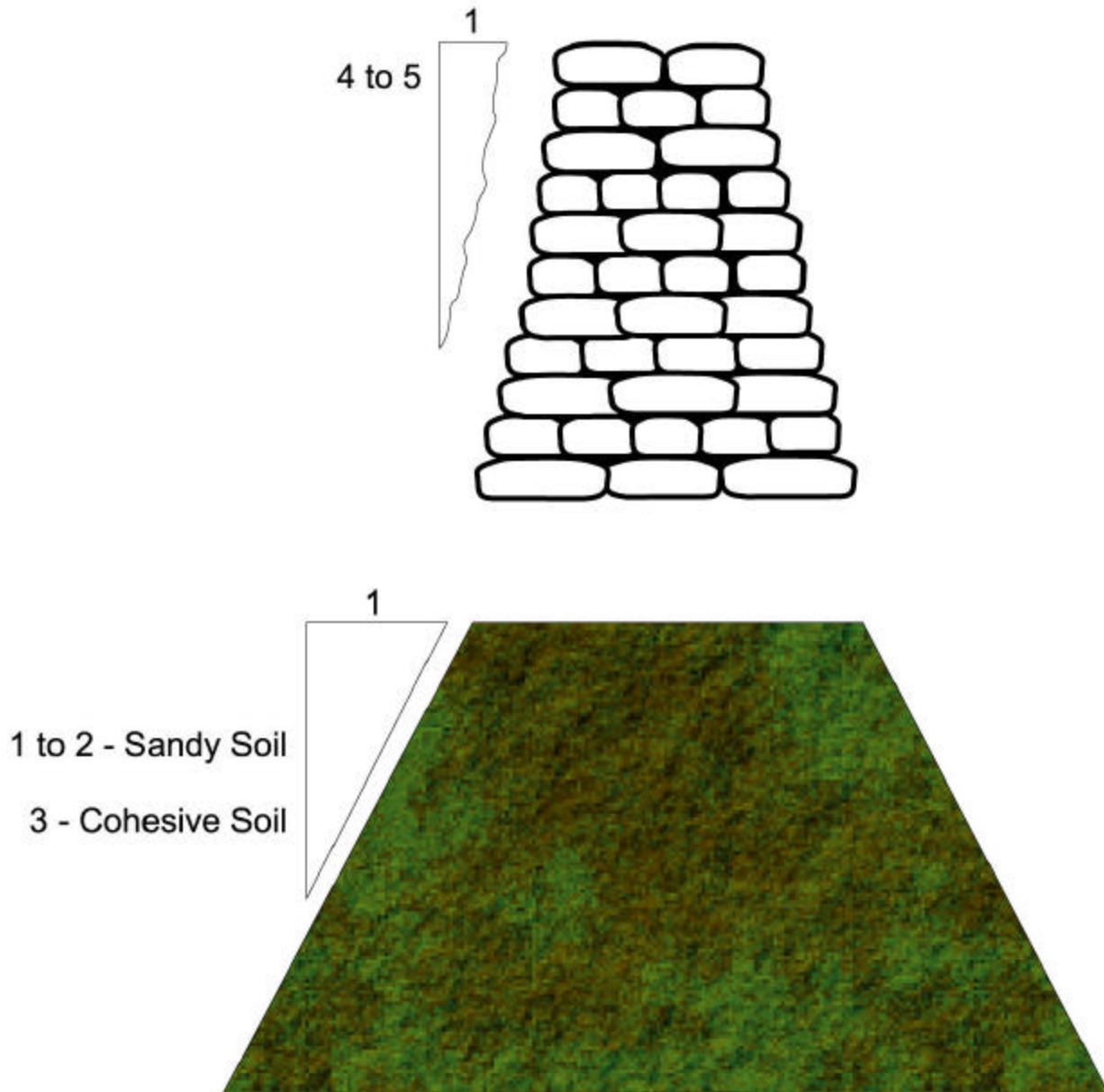


Figure 5. Berm and Revetment Slopes.



Multiple-Attack Protection. While berms and revetments have similar stopping ability for high explosive detonations and projectiles, berms provide better protection against multiple attacks. When a berm is hit, its mass tends to engulf the round and even when there is an explosive involved, the ejected matter tends to fall back onto the berm. However, sandbags lose capability after the first round impacts and damages the bags. Once the bags are damaged and begin to spill their contents, they must be replaced.

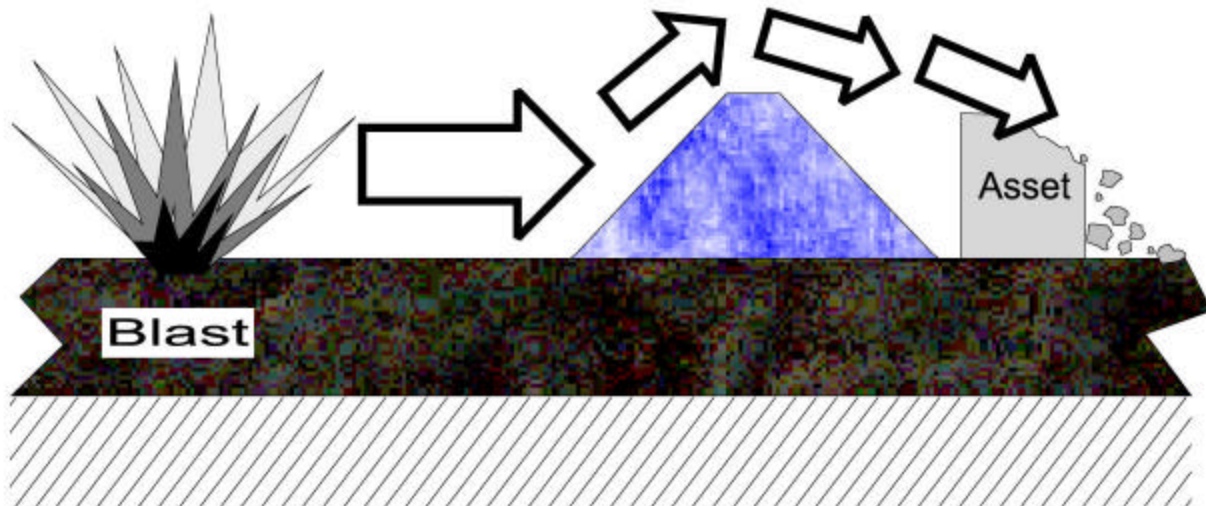
Limitations. While plastic sandbags can be used in the field with little attention for several years, berms normally require protection and maintenance. Berms must be protected from the elements, especially moisture. The sloped faces and the crest of the berm must be protected from erosion and kept waterproof. When berm material becomes saturated, it can lose up to half its strength. It may also lose its ability to provide multiple-attack protection from even small caliber projectiles. In wet climates, an internal drainage system may be required to remove moisture from the structure through the use of drains, free draining material, and/or geotextile fabrics. Sandbags are a good

means of stabilizing and providing protection for the slopes and crest of berms. Other methods used to protect the berm are to use geotextile fabrics, sod and grass or other vegetation, or for additional hardening, the use of rock, rubble, or burster slabs. Burster slabs are heavy, reinforced concrete slabs laid on the top of the berm to disrupt or deflect projectiles and close-proximity blast.

Sandbag revetments, like all revetments, may require an improved base that can withstand the higher bearing pressures of the revetment structure. Steep-sloped berms formed with densely compacted soils or by using soil cement may also require an improved base.

Shielding Placement. Berms and revetments may provide very limited blast overpressure protection for personnel and assets if the berm is not placed near enough to the asset. Freestanding berms, which have a 1:1 to 1:2 slope (Vertical to Horizontal), can allow much of the blast effect to damage a structure or asset, because the asset can not be located close enough to the berm wall (figure 6). Unless the shielding can be located very close to the asset, the overpressure will still act on the asset. Locating a berm next to an asset can be achieved by using a reinforced berm (figure 7). Two ways to do this are:

Figure 6. Blast Flow over Freestanding Berm.

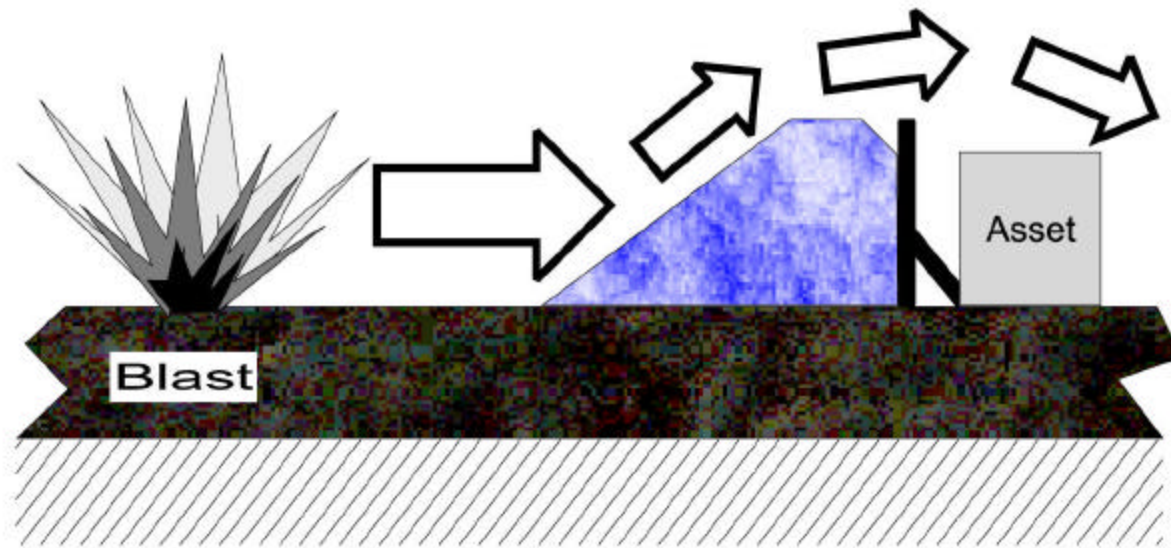
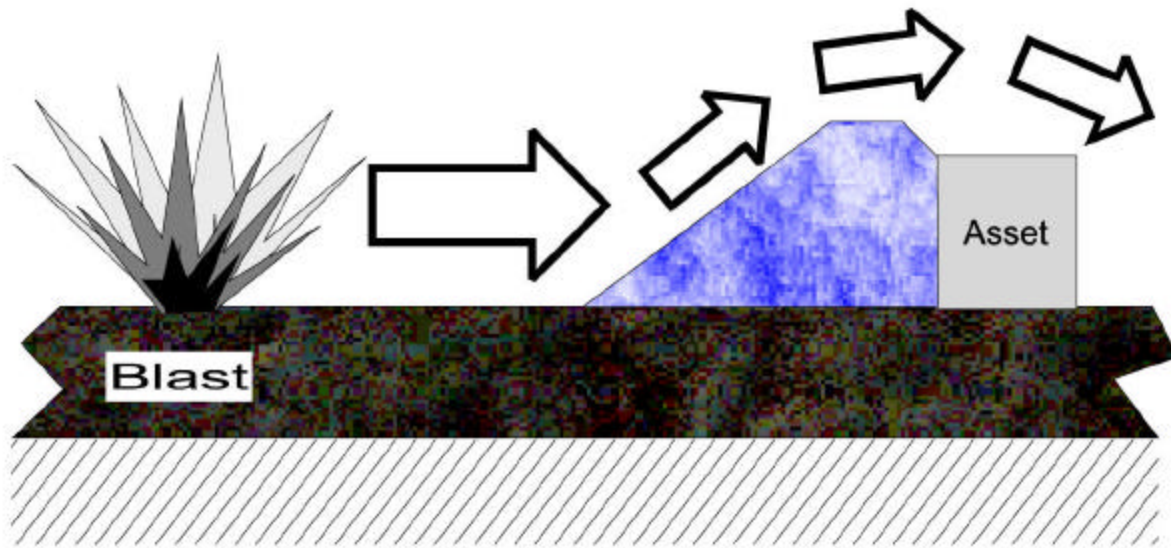


Build the berm against the structure when the walls are strong enough to support the walls or

Use a retaining wall type system to support a face of the berm so it can be closer to the asset.

Conventional wall systems can withstand limited berming to help increase the survivability of the structure. Depending on the type of soil and wall construction, part or all of the first floor can be protected when berming is used directly against the wall. Some berm heights, which may be built against conventional wall structures, are listed in Table 10.

To prevent the collapse of the structure from the soil bearing pressure, it is important that the type of soil used for berming is correctly identified. Basic soil types and there designations are listed:

Figure 7. Blast Flow over Reinforced Berm.

Type 1: Course-grained, free draining soil – washed sand (SW or SP) or gravel/broken stone (GW or GP).

Type 2: Course-grained, low permeable soil – sand, gravel, and broken stone mixed with silt (SM and GM).

Type 3: Silty sand, granular materials with high clay content, and soil with stone (SC or GC).

Type 4: Soft or very soft clay, organic silts, and soft silty clay (CL, OL, OH).

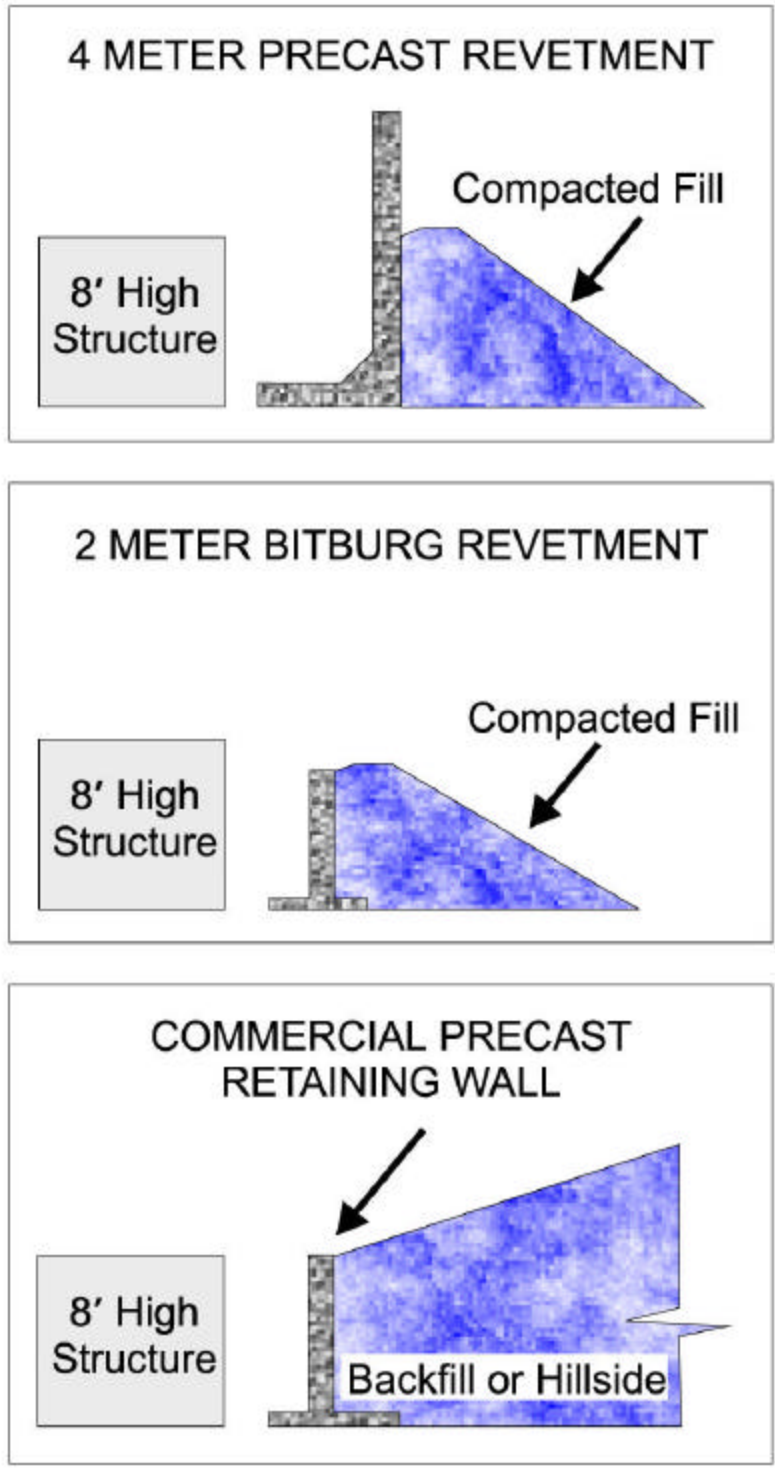
Type 5: Medium or stiff clay or organic soil that can be kept completely free of water (CH, OH, OL). **[Note: Since Type 5 material is very hard to protect from water, avoid using it for most protective construction except in very arid areas. Type 5 soil is not shown in Table 10 due to construction/moisture problems.]**

Table 10. Allowable Berm Heights for Conventional Wall Systems.

Wall System	Allowable Berm height (in feet) by Soil Type			
	1	2	3	4
8' high wood-frame walls with wood siding or brick veneer				
2 x 4 @ 16" on center (oc)	4.6	4.3	3.8	2.8
2 x 6 @ 24" oc	5.0	4.6	4.2	3.1
2 x 6 @ 16" oc	6.8	6.2	5.6	4.1
10' high un-reinforced concrete masonry walls				
8" hollow CMU	5.4	4.8	4.3	3.3
12" hollow CMU	6.7	6.2	5.6	4.4
8" filled/grouted solid CMU	8.1	7.5	6.6	4.9
12" filled/grouted solid CMU	10.0	10.0	10.0	6.9
16' high precast concrete wall panel, 6" thick	9.3	8.7	7.8	5.8
24' high precast concrete wall panel, 6" thick	11.9	11.1	10.1	7.6

It is possible to use freestanding, precast concrete revetments such as the 4-meter aircraft and 2-meter Bitburg revetments as a part of a retaining wall for a berm. In some locations where normal area construction requirements call for the use of precast concrete retaining walls, retaining walls may be commonly available for use in berm or slope protection. Figure 8 shows typical uses of these structures.

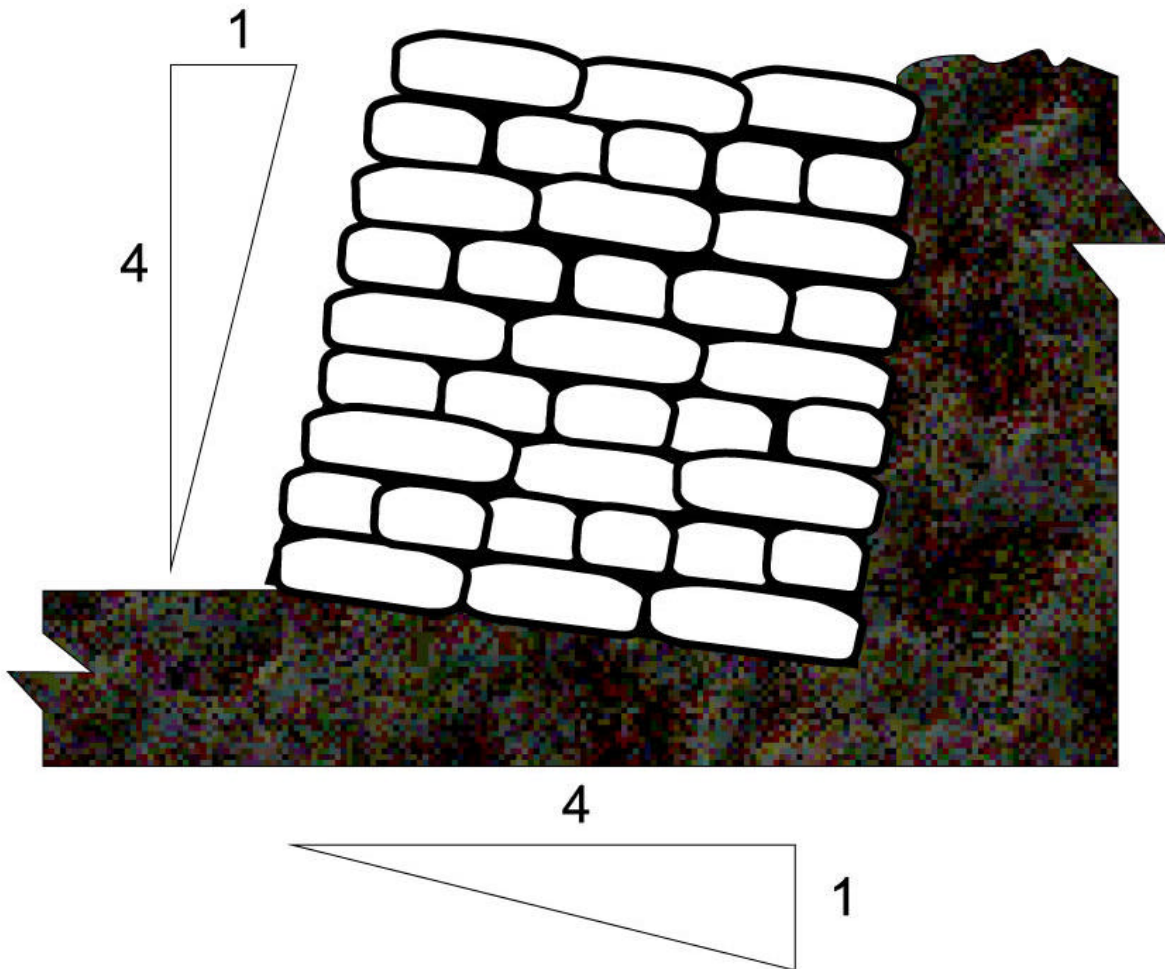
Figure 8. Precast Concrete Revetments/Retaining Walls.



If retaining wall structures will be used to stabilize or support either tall slopes or tall backfilled slopes protecting assets, then this type structure needs to be **designed** based on the types of soils and retaining walls available. The use of any soft, medium, or stiff clays, organic silts, or soft silty day soils (i.e., soil Types 4 and 5) is **not recommended for use with tall or steep slopes, especially where precipitation is high.**

Stabilizing a Soil Face. An earth face may have to be stabilized to prevent collapse of the soil, such as when an asset must be positioned close to slope, which has been partially excavated. Table 10 showed that there was a limit on the berm height allowed against a structure based on the type of soil in a berm. When a soil face must be stabilized or retained, sandbags may be used. The sandbags and slope should be cut at a 4:1 slope (Vertical to Horizontal) and the base of the sandbags should be cut in at 1:4 slope (figure 9) (Vertical to Horizontal).

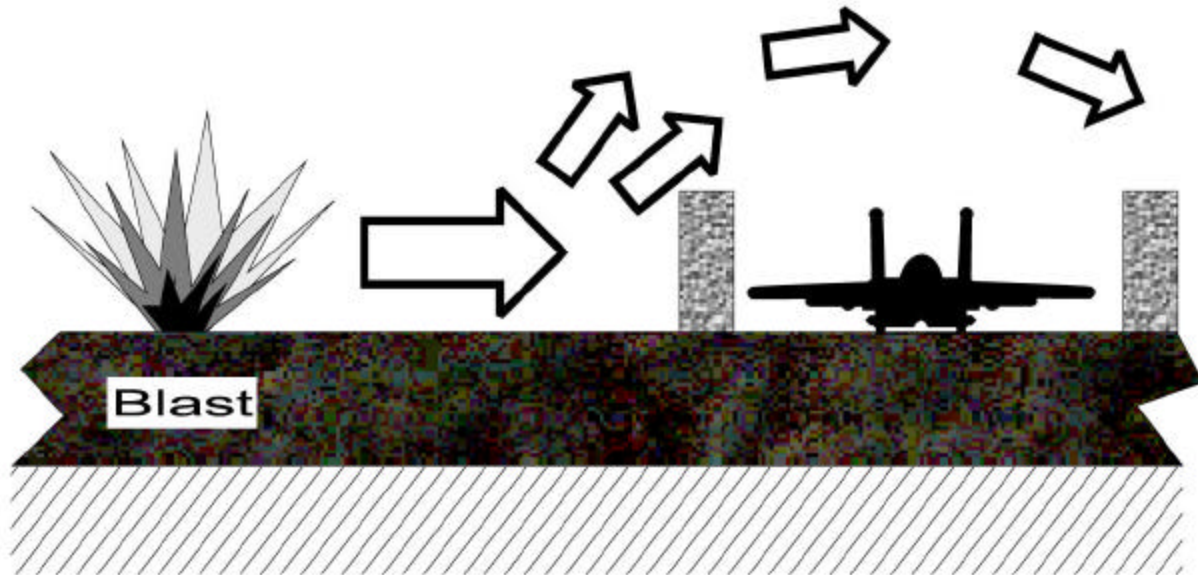
Figure 9. Sandbags Cut into a Slope.



Shielding Shape. Because of their shape (i.e., low sloped faces and usually lower heights), earth berms and even sandbagged revetments have limited use for protecting weapons systems and critical facilities to support aircraft. To intercept and deflect or otherwise control the blast from a conventional bomb (ground burst), **tall, vertical, reinforced faces** are required. These faces will not only confine the shielding material, but will also allow the aircraft to be kept close enough to the walls to be afforded protection from horizontal blast (figure 10) as it passes over the structure. Reinforced concrete revetments, metal and reinforced fabric (Concertainer) bins, and concrete

revetments with soil fill are much more effective for protection of aircraft. When maintained and constructed properly, they will retain most of their fill without spilling into the protected area after a nearby bomb explosion.

Figure 10. Blast Flow around Vertical Berms.



OVERHEAD COVER CONSIDERATIONS.

To obtain much greater levels of protection from blast, fragmentation, and direct- and indirect-fired munitions, placing a reinforced or protective earth structure over the asset is necessary. While providing an expedient overhead cover may not be possible for all assets (such as aircraft), many situations exist where a protective overhead cover can be used with a revetment, a partially buried or bermed structure, or a bermed revetment. Tables 6 and 7 provide information on thicknesses of materials to withstand direct-fired projectiles and near miss explosions. For indirect-fired weapons that have contact or delayed fuzes, additional support is required and information on the weapons is needed before field construction.

Structural Reinforcing. The amount of sandbag or earth cover necessary for direct- and indirect-fired weapons protection usually weighs more than a roof structure can withstand. Therefore the cover materials have to be supported with additional structural members. Structural members span the opening and provide support for the cover materials. Some commonly available materials that can be used as structural members are timber, structural (dimensioned) lumber, structural steel, steel shapes, metal pipe, utility poles, and railroad ties. Sheathing is used between the structural members and the earth or sandbag cover to transfer the loads and keep loose materials from falling on personnel or assets. Commonly available materials used for sheathing are corrugated metal sheets, steel planking, AM-2 matting, plywood and OSB sheathing, and wooden boards.

Material availability depends on the location and the amount of time and transportation support available. Some of the most commonly available materials for expedient construction will be timber or lumber, either transported in or locally purchased on the economy. When available, raw timber can be used in lieu of dimensioned lumber for expedient construction; Table 11 provides a conversion for equivalent sizes of timber and dimensioned lumber.

Table 11. Equivalent Sizes of Timber Compared with Dimensioned Lumber.

Cut Timber/Log Diameter (in inches)	Equivalent Size of Dimensioned Lumber (in inches)
5	4 x 4
7	6 x 6
8	6 x 8
10	8 x 8
11	8 x 10
12	10 x 10
13	10 x 12
14	12 x 12

Make sure, especially for the longer spans, that the timber is solid and does not have decay or rot damage. Freshly cut timber can bend or warp more than already seasoned timber or dried (dimensioned) lumber. Freshly cut timber has a higher moisture content and may have only about 75% of the resistance to bending of dried or seasoned wood. Some softwoods (such as Norway Pine, numerous Cedars and Spruces, White Fir, and Hemlocks) also may have less than 75% of the bending resistance of other woods. When designing structures for thick earth covers and longer unsupported spans, if softwoods or green timber with a high moisture content will be used, consider decreasing the equivalent sizes for dimensioned lumber to the next smaller size when determining allowable span lengths. This is especially important if the structure will be used for extended deployments.

Example: A fighting position will be used for at least 18 months during several rainy seasons. It is planned to use freshly cut 8-inch diameter Norway Pine to support 5 feet of earth cover for a 6 foot span to protect against 152-mm high explosive shells. While an 8-inch diameter log is normally equivalent to 6 x 8 dimensioned lumber, when using the design tables, use at least the next smaller size of lumber (i.e., 6 x 6) for making determinations for stringer span and spacing. This is because Norway Pine is a green softwood that will continue to be damp for long periods of use.

Basic Design Guidance. There are three classes of weapons (i.e., direct fired, indirect-fired with contact fuzes, and indirect-fired with delayed fuzes) that normally require differing degrees of overhead protection.

For protection against **smaller caliber direct-fired weapons and fragmentation**, Tables 12 and 13 should be used as guidelines. Table 12 provides the allowable unsupported (span) distance for lumber members (called stringers) and the allowable on-center (OC) spacing between the lumber for supporting thickness of earth or sandbag cover. Figure 11 depicts the span distance, OC spacing for stringers, and depth of cover for a fighting position.

Figure 11. Stringer Span Distance/On-Center Spacing for Fighting Positions.

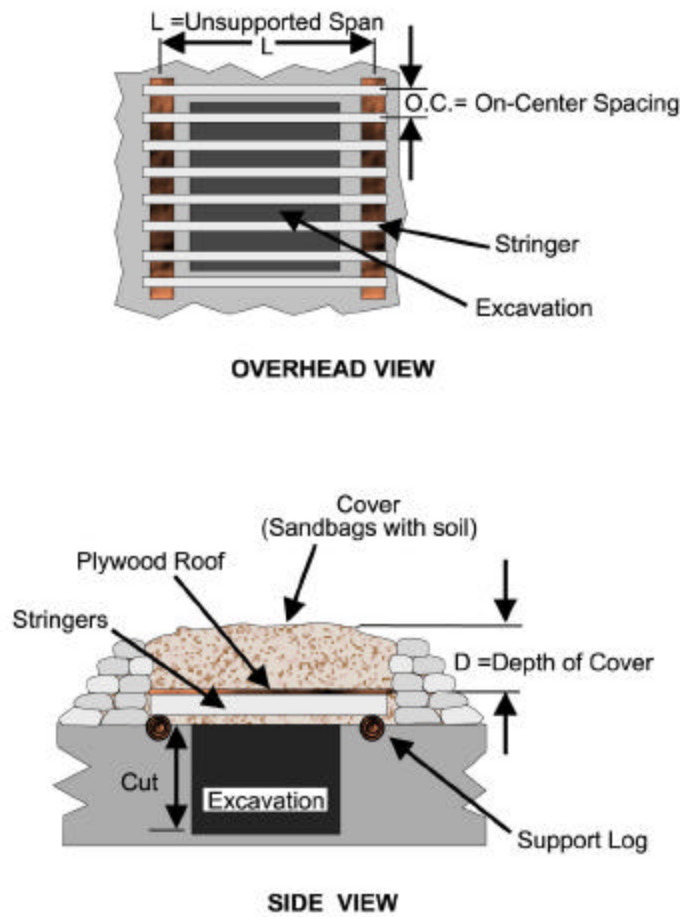


Table 12. Maximum Span and On-Center Spacing for Stringers.

Thickness of Earth Cover (in feet)	Maximum Span Length (in feet)					
	2.5	3	3.5	4	5	6
	Maximum OC Spacing (in inches)					
1.5	40	30	22	16	10	<u>18</u>
2	33	22	16	12	8 or <u>20</u>	<u>14</u>
2.5	27	18	12	10	<u>16</u>	<u>10</u>
3	22	14	10	8 or <u>20</u>	<u>14</u>	<u>8</u>
3.5	18	12	8 or <u>24</u>	<u>18</u>	<u>12</u>	<u>8</u>
4	16	10	8 or <u>20</u>	<u>10</u>	<u>10</u>	<u>7</u>

OC spacing is for 2 x 4 stringers, except underlined values are for 2 x 6 stringers.

Table 13 provides the minimum thickness of wood sheathing or wood board (for nominal sizes) in inches that must be used over the stringers to distribute the weight of the earth or sandbag cover. It is used with the maximum unsupported (span) distance of lumber used in Table 12.

Table 13. Minimum Thickness of Sheathing over Stringers.

Thickness of Earth Cover (in feet)	Maximum Span Length (in feet)					
	2.5	3	3.5	4	5	6
	Minimum Thickness of Sheathing or Wood Board (nominal size in inches)					
1.5	1	1	2	2	2	2
2	1	2	2	2	2	3
2.5	1	2	2	2	2	3
3	2	2	2	2	3	3
3.5	2	2	2	2	3	3
4	2	2	2	2	3	4

For protection against heavier **indirect-fired weapons with contact fuzes**, the depth of soil and size of wooden support members must be increased. Table 14 provides design guidelines for protection from several characteristic weapons (i.e., mortars, rockets, and high explosive shells) with contact fuzes. It is based on the thickness of earth or sandbag cover and the span distance and spacing for stringers. The span distance is limited to a maximum of 18 inches to allow the use of standard sheathing thicknesses: 1-inch sheathing for 82-mm weapons and 2-inch sheathing for 120-mm, 122-mm, and 152-mm weapons.

Table 14. Design Guidelines for Protection from Select Indirect-fired Munitions (Contact Fuze).

Stringer Dimensions (nominal size in inches)	Thickness of Earth Cover (in feet)	Maximum Stringer Span Width (in feet)				
		2	4	6	8	10
		Maximum Stringer OC Spacing (in inches)				
Protection against 82-mm Mortar – 1" plywood sheathing						
2 x 4	2	3	4	4	4	3
	3	18	12	8	5	3
	4	18	14	7	4	3
2 x 6	2	4	7	8	8	6
	3	18	18	16	12	8
	4	18	18	18	11	7
4 x 4	2	7	10	10	9	7
	3	18	18	18	12	8
	4	18	18	18	10	7
4 x 8	1.5	4	5	7	8	8
	2	14	18	18	18	18
	3	18	18	18	18	18
Protection against 120-mm Mortar and 122-mm Rocket and HE Shell – 2" Plywood sheathing						
4 x 8	4	3.5	4	5	5	6
	5	12	12	12	11	10
	6	18	18	18	16	12
6 x 6	4	--	--	5.5	6	6
	5	14	14	13	12	10
	6	18	18	18	16	12
6 x 8	4	5.5	6	8	9	10
	5	18	18	18	18	18
8 x 8	4	7.5	9	11	12	13
	5	18	18	18	18	18
Protection against 152-mm HE Shell – 2" Plywood sheathing						
4 x 8	4	--	--	--	--	3.5
	5	6	6	7	7	7
	6	17	16	14	12	10
	7	18	18	18	15	11

Stringer Dimensions (nominal size in inches)	Thickness of Earth Cover (in feet)	Maximum Stringer Span Width (in feet)				
		2	4	6	8	10
		Maximum Stringer OC Spacing (in inches)				
6 x 6	4	--	--	--	--	3.5
	5	6	6	7	7	7
	6	18	18	15	12	10
6 x 8	4	--	--	--	--	5
	5	10	11	12	12	12
	6	18	18	18	18	17
8 x 8	4	--	--	--	--	8
	5	14	15	16	17	16
	6	18	18	18	18	18

Note: Where no value is shown for spacing, choose the next greater thickness of earth cover.

For protection against **indirect-fired weapons with delayed fuzes**, in addition to providing the protective overhead mass type cover (i.e., sandbags, sand, or dirt), several layers of large rocks or a burster slab must also be placed on top of the dirt. The top covering rocks (or slab) are used to defeat penetration of the delayed fuze shells and cause detonation prior to deep penetration into the protective overhead mass cover material.

Table 15 provides guidance for choosing a burster layer of material for basic weapon types. Ensure that the structural members can support the additional weight of the rock or stone layers.

Table 15. Required Thickness of Cover for Protection against In-Direct and Direct-Fired Weapons (Delayed Fuze).

Type of Shell	Concrete Slab Thickness (in inches)	Rock Thickness (in inches)
82-mm Mortar	6	20
120-mm Mortar	20	36
122-mm Rocket	60	40
122-mm Artillery HE	68	40
130-mm Artillery HE	60	42

Concrete to be reinforced, minimum of 3,000-psi.
Rock to have a minimum compressive strength of 20,000 psi.

For expedient construction, rocks are normally used as the burster layer (figure 12). Expedient construction using precast slabs as burster slabs is usually limited to protection against smaller weapons, such as the 82-mm mortars, even when precast concrete roadway or runway repair slabs are available. This is due to the greater thicknesses of concrete required to defeat larger size shells. When using rocks for thicknesses of burster layers greater than 6 inches, the rocks should be placed in at least 3 to 4 layers to provide better quality control of placement. Ensure that the edges of large rocks fit together like a puzzle and do not align vertically. It is better to place the rocks in loose layers instead of stacking them with gabion type bins. The rock size should be approximately two times the size of the weapon's caliber. Rock sizes should be rounded up to the closest available size that meets the minimum diameter.

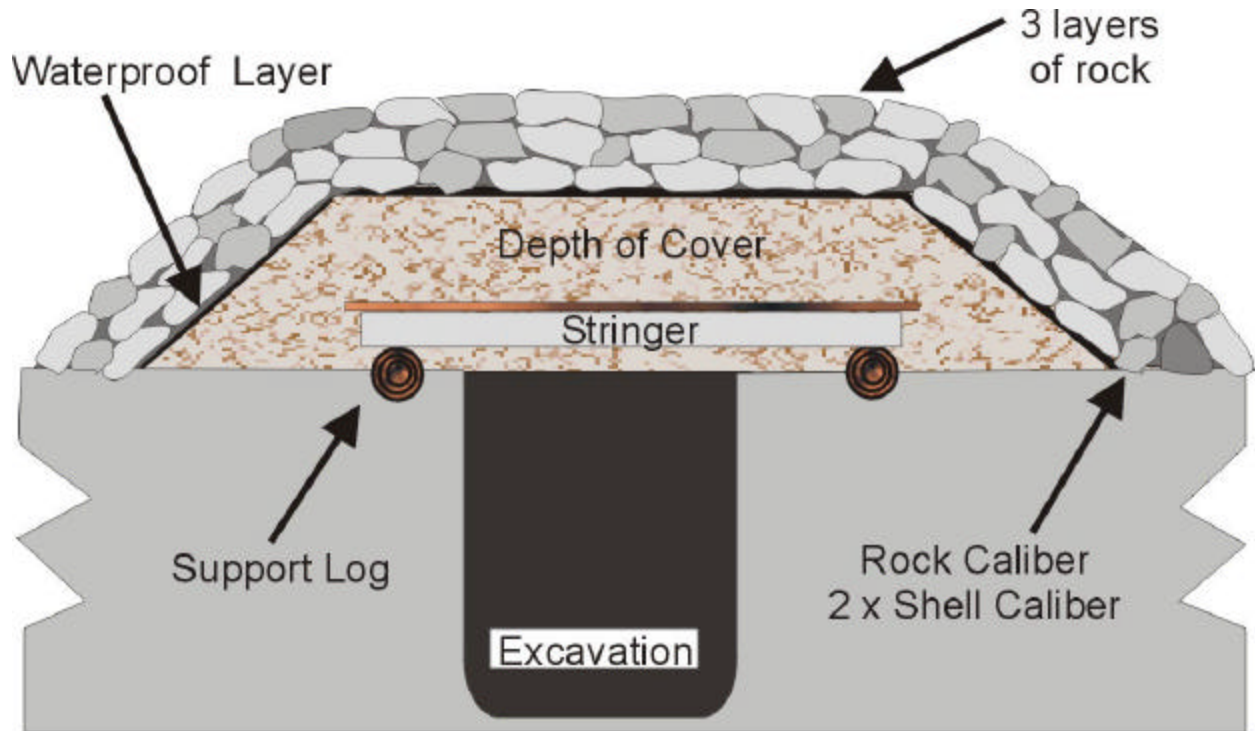
Example: Determine the rock size for protection against a 122-mm HE artillery round.

Rock size = 2 x (122 mm ÷ 25.4 mm/inch)

Rock size = 2 x 4.8 inches

Rock size = 9.6 inches (minimum). Rounding up, use a **10-inch diameter rock** or the next closest size of rock available.

Figure 12. Burster Rock Layer over Hardened Position.



**STONE LAYERS ADDED TO TYPICAL OVERHEAD COVER
TO DEFEAT THE DELAY FUZE BURST**



CONSTRUCTION

This chapter provides the basic construction requirements for expedient revetments, obstacles, and fighting positions, that can be field constructed with deployed materials or locally available materials. For longer deployments, it may be possible to contract for, or construct, concrete revetments. **Effective predeployment planning is critical** to determine what you can use to protect your mission assets and yourselves. This chapter also presents basic siting and construction information for deployed forces, and provides experienced, qualified personnel with the requirements to help design and construct expedient structures. Prior to deployment, consider your deployment needs and review the documents cited in the Introduction. If concrete systems are feasible for use, especially those for precast concrete, the basic designs are found in AFPAM 10-219, Volume 2 and should be copied or downloaded prior to deployment.

Be aware, most often there are two key ingredients required for construction of expedient revetments and fighting positions -- ingenuity and plenty of sandbags. Following are descriptions and/or depictions of basic structures along with information or cautions on their use.

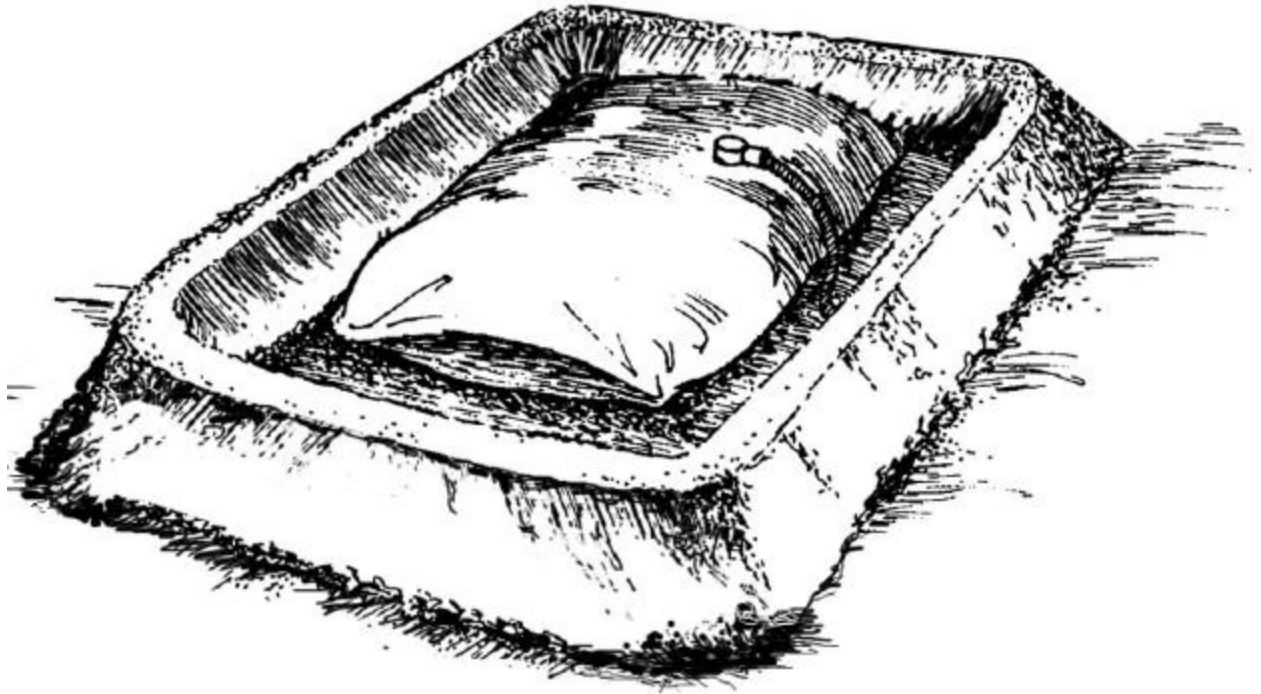
REVETMENTS.

Defined in basic terms, a revetment is a raised structure that provides a level of protection against blast, splinters, shrapnel, and/or projectiles from bombs, rockets, grenades, small arms fire, or other weapon effects. The following structures are examples of revetments that can be used by Civil Engineers.

Berms:

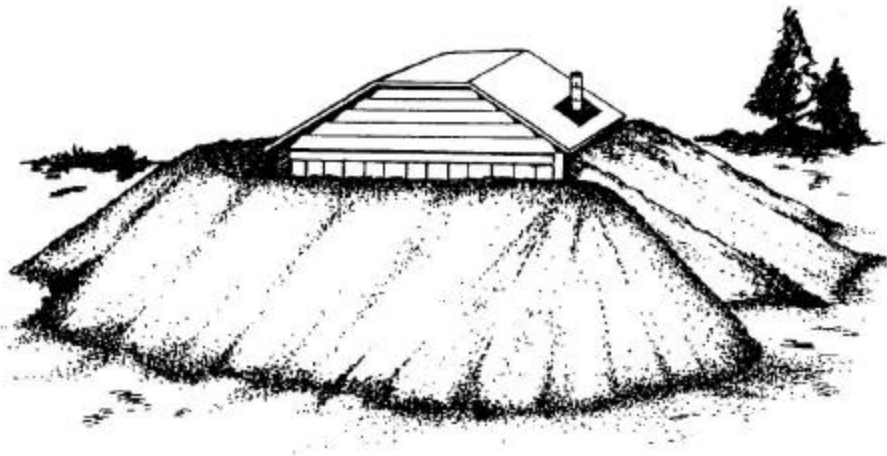
Freestanding Berm (figure 13). A freestanding berm is constructed with soil or sand. Depending on the material used, the material may be placed loose (such as with a granular material) or compacted (such as with a cohesive material). The sides should be sloped at between 1:1 and 1:2 (Vertical to Horizontal). Covering with vegetation such as sod, a geotextile fabric, rock, or other material is usually required to protect berms from wind and rain erosion on the faces. Sandbags may also be used to protect the berm's faces, especially when loose material is used.

Figure 13. Freestanding Berm Protecting a Fuel Bladder.



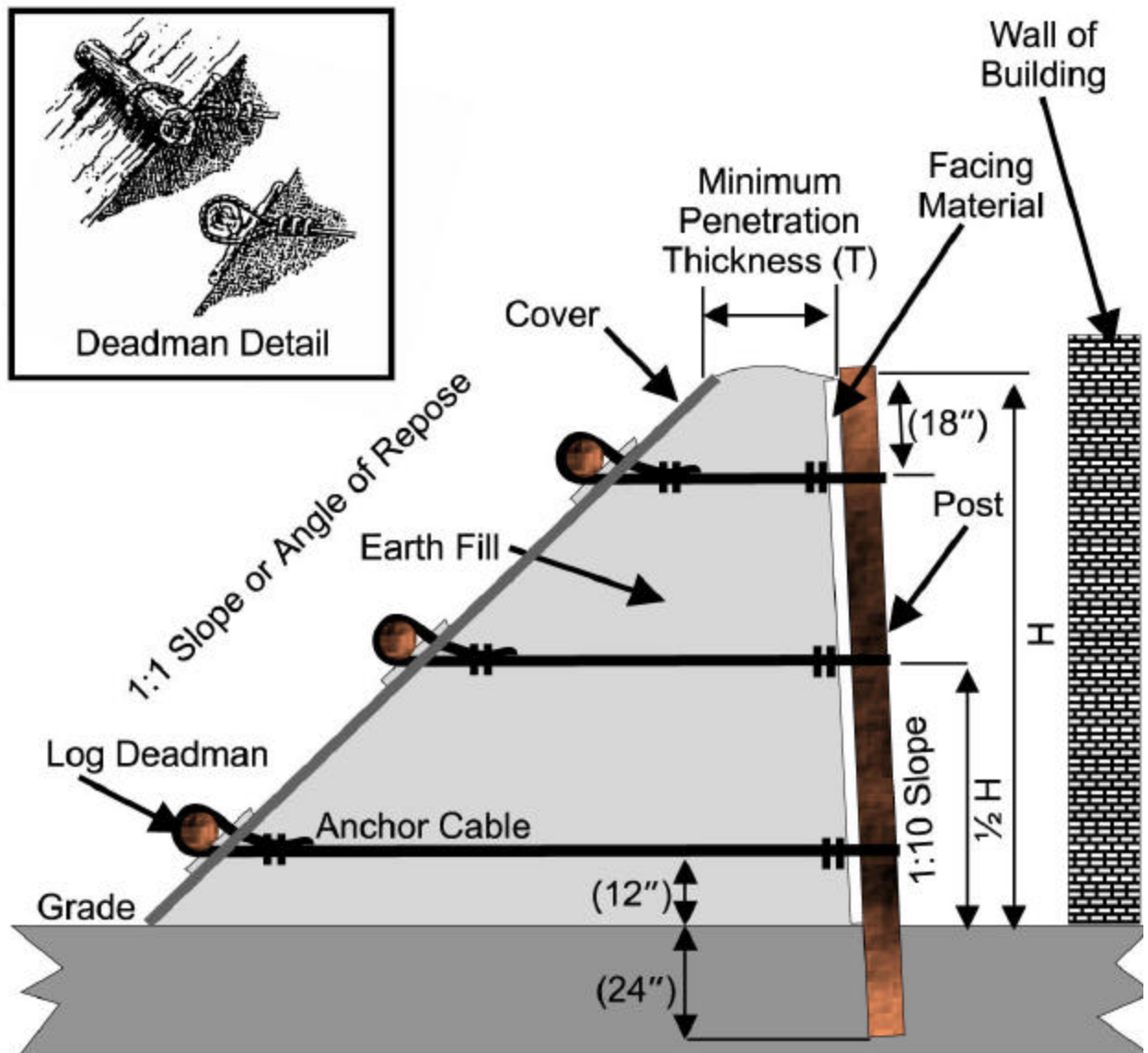
Berm against a Structure (figure 14). Berms can be placed against the wall of a structure if the structure is able to support the additional loading of the berm materials; see Table 10 for some common allowable berm heights. If additional protection is required, the berm may be continued over the top of the structure if the structure will support the loading. Supplemental roof support may be required, such as extending support beams onto the berm or a revetment built against the building prior to placing berm materials.

Figure 14. Berm against a Building.



If the structure cannot withstand the force of the berm against its walls, the berm face closest to the building may be braced with a structural facing material and pipes, poles, or lumber holding the facing in place near the walls (figure 15). The braced face may be a landing mat, corrugated metal sheets, reinforced plywood, or other structural facing material. The facing material is tied to deadman supports that are either exposed on the sloped face of the berm (i.e., a braced berm) or covered by being buried under the berm.

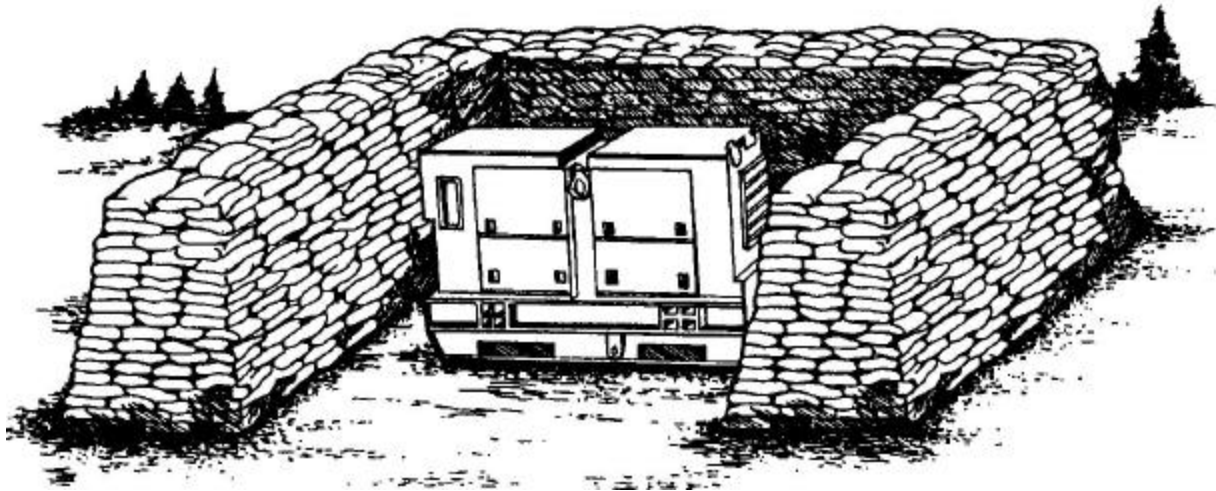
Figure 15. Braced Face of Berm near Building.



Revetments.

Freestanding:

Sandbag Walls. Sandbag walls may be constructed either as sloped or partially braced structures. A freestanding, sloped sandbag revetment (as depicted in the top portion of figure 5) has sloped faces and is placed near a structure or asset (figure 16).

Figure 16. Freestanding Sloped Sandbag Revetment.

To be effective, sandbags must be properly placed. Follow these steps.

Fill the bags about 3/4 full with earth, sand, or a dry soil-cement mixture. The bags should not be too full as to prevent the bags from being flattened and shaped. To fill in voids between whole bags, just fill the bags with less soil. Do not try to overfill several bags to avoid having voids.

Tie the choke cords and tuck the bottom corners after they are filled.

Place the bags so the choked end of the bag (i.e., the end where the bag is closed) and the side seams are turned inward away from the threat.

Lay the first course as a header (i.e., the bags are laid so that the long direction of the bags is perpendicular to the wall). Lay the next course with the bags parallel to the wall; bags laid this way are called stretchers.

Alternate the succeeding courses. Make sure that the stretchers and headers have staggered joints between courses.

Slope the sides and the revetments as previously discussed and as dictated by the conditions and use.

Additional strength and stability can be provided to a sandbagged revetment by creating a partially braced structure (figure 17). Use landing mat, corrugated metal sheets, reinforced plywood, or other structural facing material on the vertical face of the sandbag revetment and tie it to the sloped face for support. This is basically the same structure that is used with an earth berm with a braced face.

If the structure can withstand the additional side load, the sandbag revetment may be built with a straight face against the wall of the structure (figure 18). The sandbag revetment can be used to partially support supplemental roof support beams (figure 19).

Figure 17. Partially Braced Sandbag Revetment.

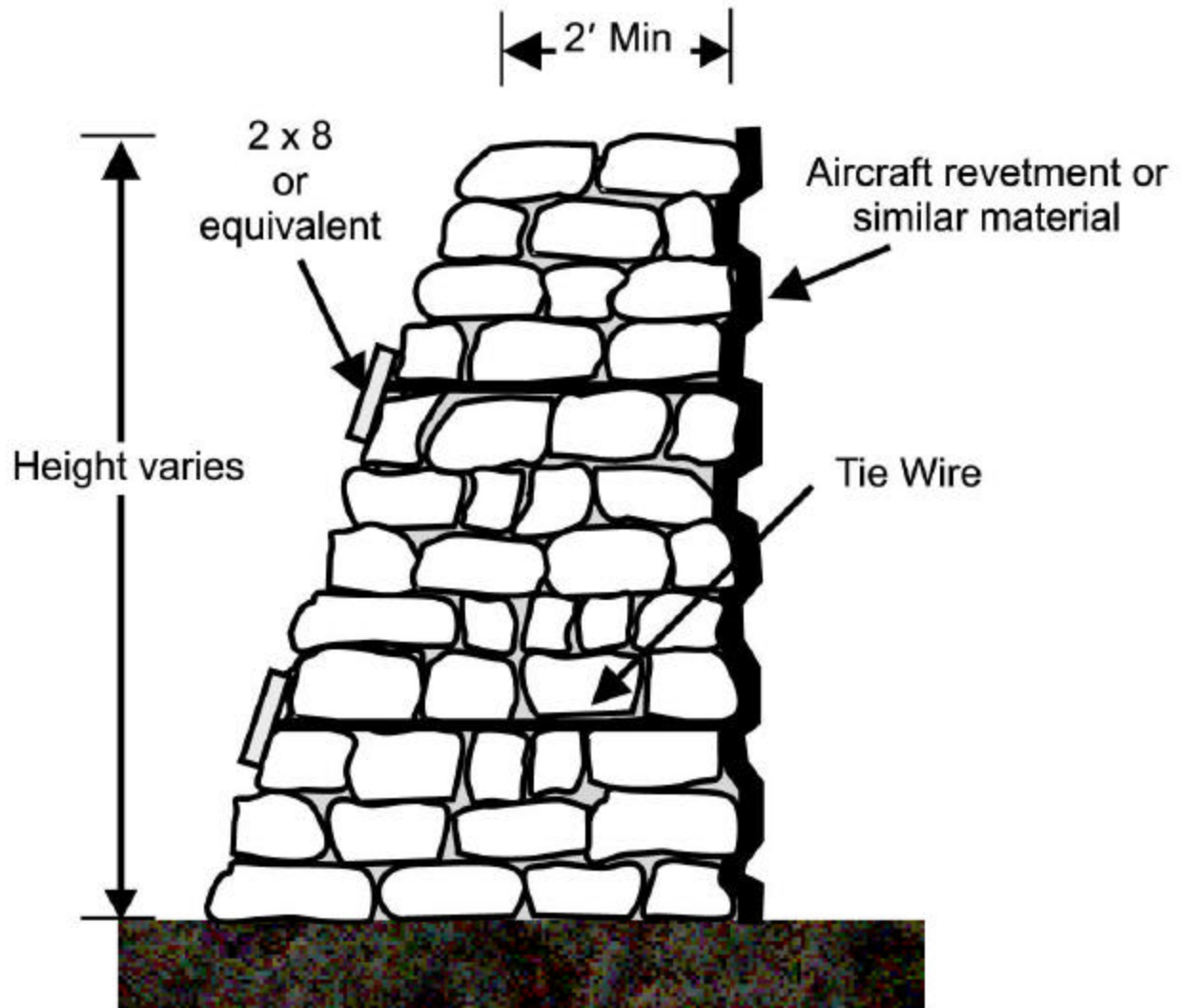


Figure 18. Sandbags against a Structure.

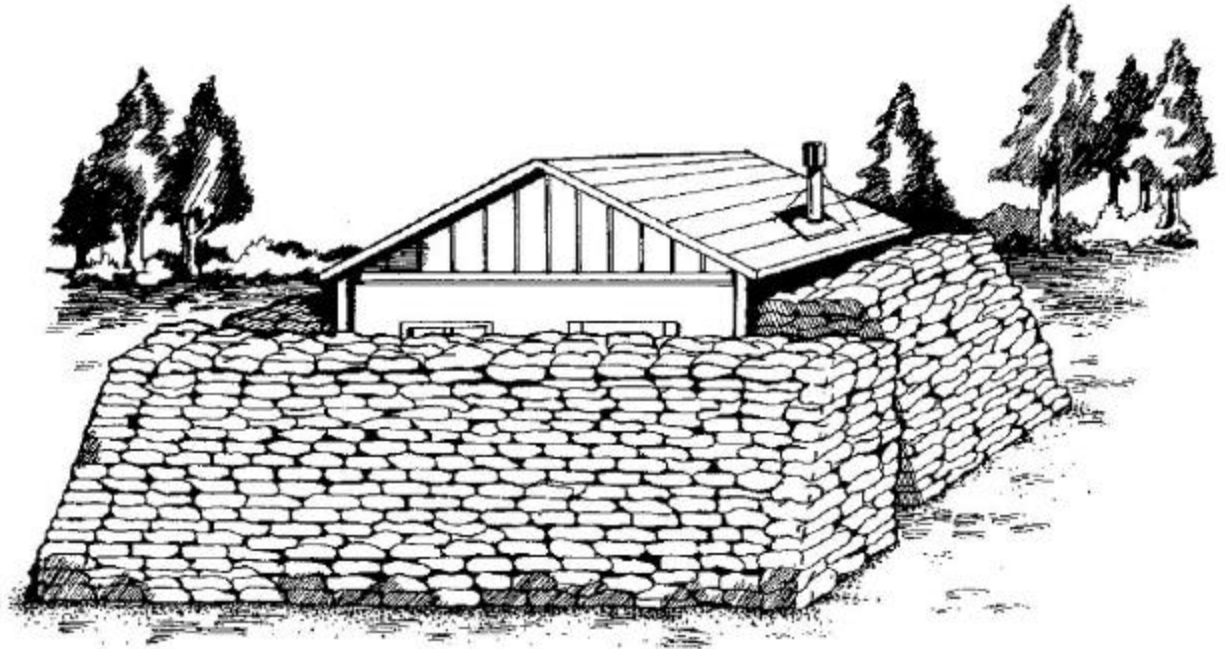
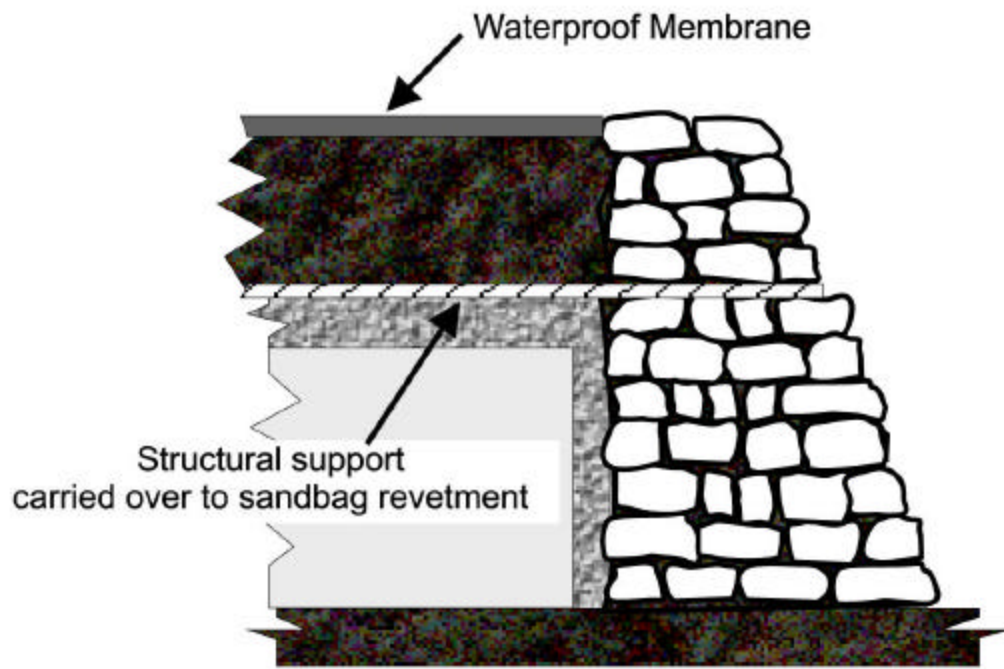


Figure 19. Sandbags Help Support Roof Covering.

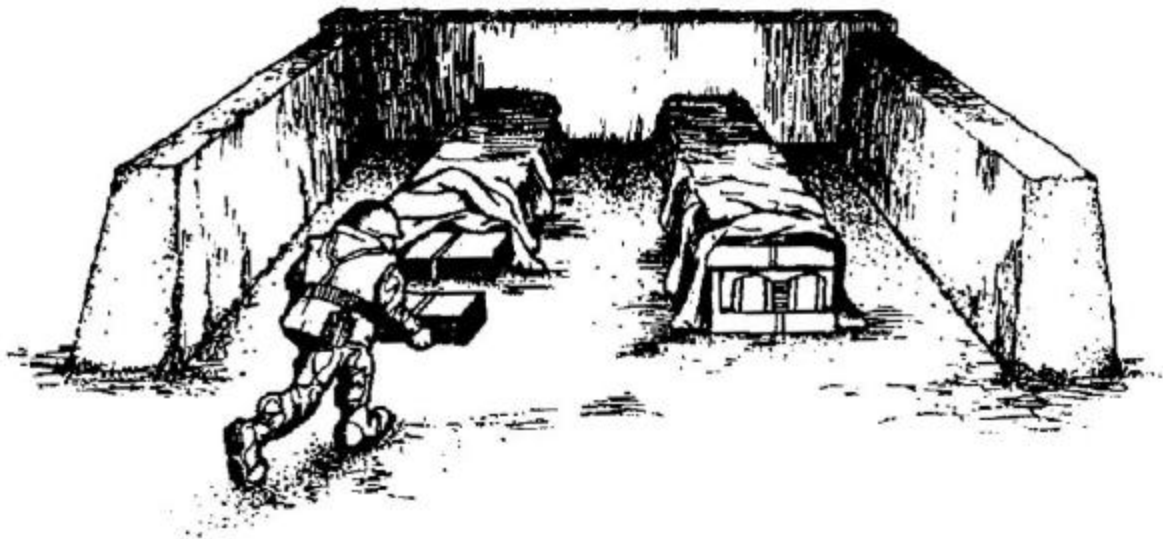


NOTE: Soil fill placed such that existing roof pitch is maintained for drainage

Soil-Cement Sandbags. Mix the sandbag fill material with dry Portland cement (1 part Portland cement to 10 parts soil or 1 part Portland cement to 6 parts sand or sand/gravel). Stack the bags as you would for a normal sandbag wall. The sandbag revetments will become increasingly more stable as the cement takes on moisture and cures.

Soil-Cement Wall (figure 20). Soil-cement walls provide greater protection from fragmentation while taking up much less surface area than an earth berm. The walls can be constructed with a 10:1 (vertical to horizontal) slope and should provide a minimum 2-foot wide crest at the top of the wall. Constructing the wall requires formwork and equipment to mix the soil-cement. Depending on the height of the wall, the area under this type wall may require a higher bearing capacity than a soil berm, and therefore may also have to be improved with a mixture of cement. Higher walls may have to be built in several lifts, but if possible, build the forms strong enough to allow forming in one (or two) lifts. If lifts are used, consider using some form of doweling between the lifts. The amount of water (required to moisten the mixture and allow hydration of the cement) and the ratio of cement-to-soil (by weight) will vary based on the soil type. Generally 1 part Portland cement to 10 parts soil is used for soil-cement construction.

Figure 20. Soil-Cement Wall.



Concrete Modular Revetments: Prefabricated concrete revetments are an expedient method to protect exposed assets and facilities. They are portable and are designed for placement by either a crane or a 10-ton forklift. They can be used in areas that require protection from fragmentation, airblast from near-miss general-purpose bombs, and high explosive (HE) artillery shells, rockets, mortars, and small arms. When used on their own (without berming), they provide good protection against first strike attacks, but may provide only limited protection from follow-on attacks due to susceptibility to fragment damage, spalling, and displacement of the slab structures. During subsequent attacks, the weakened or displaced slabs could allow fragments and blast to penetrate a protected position. In general, the edges of most revetments do not have overlapping surfaces at corners. Therefore, the corners may require additional reinforcing, such as with sandbags.

While not specifically discussed below, if available through the local economy, precast retaining walls may also be used as a concrete modular revetment to provide limited protection for assets. Try to determine if the retaining walls have enough steel to prevent collapse when damaged. They should have a minimum 28-day compressive strength of 2,500 psi, but 3,000- to 4,000-psi is preferred.

Bitburg Revetment. The Bitburg revetment is a one-piece, precast concrete revetment that is 2 meters high by 2 meters wide by 30 cm thick. A base with two sets of flanges stabilizes the freestanding

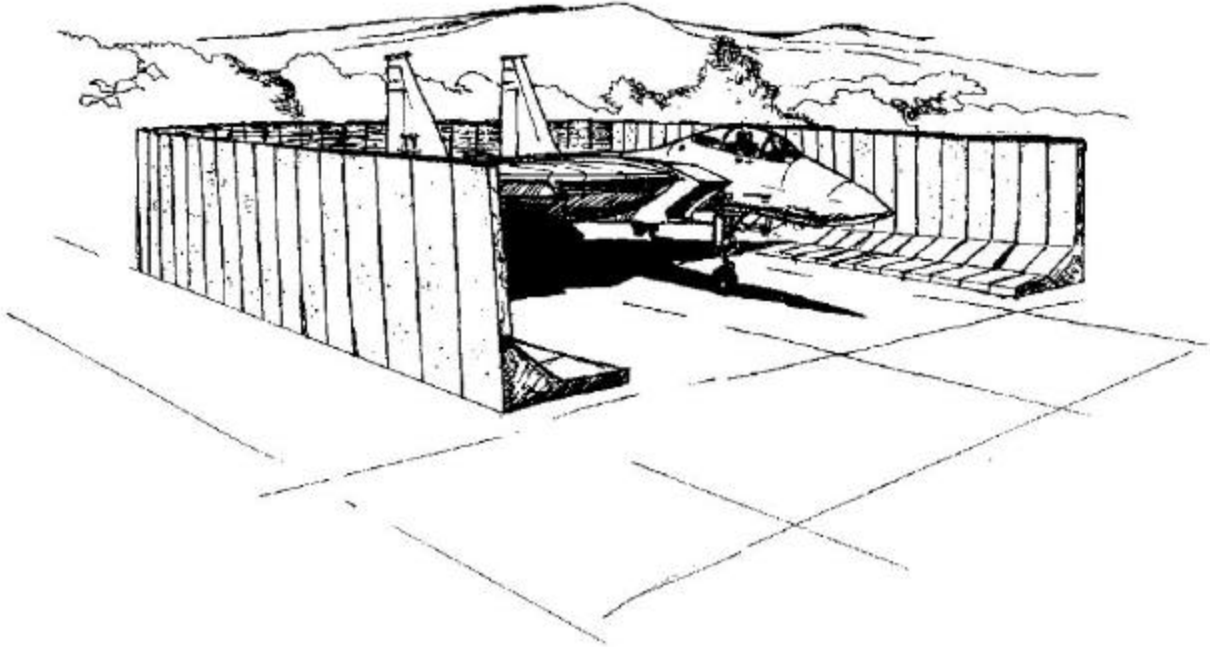
revetments. The flanges allow the revetments to be butted together in either a straight line or with 90-degree corners. The units are manufactured ahead of time by contract, stored, and moved into position with forklifts (figure 21). The units can be used as a freestanding revetment or as a support wall for a berm (see figure 39).

Figure 21. Bitburg Revetments.



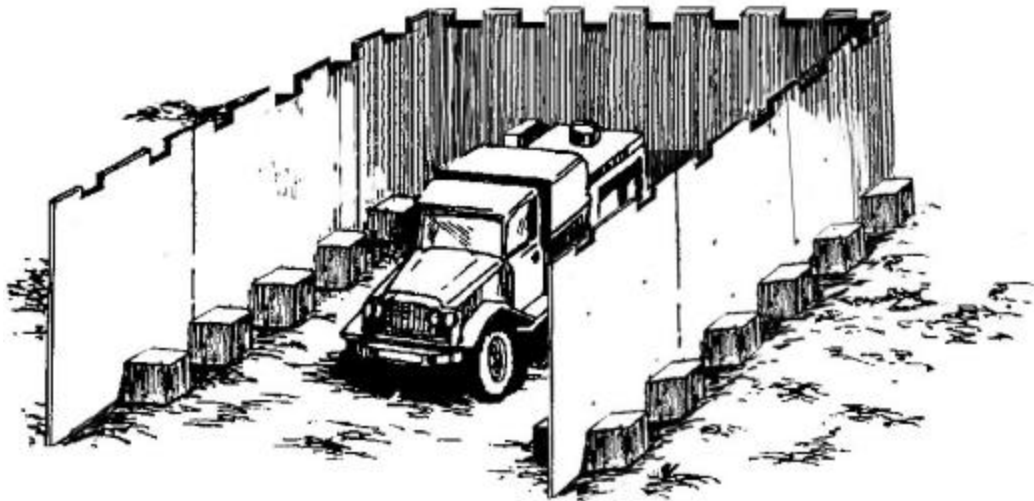
Four-Meter Aircraft Revetment. The 4-meter aircraft revetment (figure 22) is a one-piece, L-shaped, precast concrete revetment that is 4 meters high, 1 meter wide, 2.2 meters deep, and 24.5 cm thick. The freestanding units can be butted together side-by-side. One line of revetments may be butted up against another line of revetments at a 90-degree angle only by reversing the direction of abutting corner revetments, as the flanges are not relieved like the Bitburg revetment's base flanges. Although cumbersome, the units are versatile in that they can be used with berms to effectively protect one story buildings, or they can be placed in double rows to be used as bin revetments (see figure 33) for greater blast protection of aircraft.

Figure 22. Four-Meter Aircraft Revetments.



Portable Precast Concrete Wall. The portable precast concrete revetment (figure 23) consists of a wall section with two notches that fit into two separate, notched footings of precast concrete. The revetment is normally is 15 cm thick and 2.4 meters wide; it may be constructed in 1.5-, 2.1-, 3-, and 4.5-meter heights. The freestanding units can be butted together side-by-side and at 90-degree corners, and can also be used with berms.

Figure 23. Portable Precast Concrete Wall.



Bin Revetments: Bin revetments are just about any structure that can be used to contain shielding materials, such as rocks, gravel, sand, and soil. Wire fencing or mesh can be used to contain rocks or rubble. Wire and fabric boxes, precast concrete shapes, tires, and manufactured metal bins are just a few of the materials that can be used to contain sand and soil. Especially for revetments with large mass, the revetments must be installed on a stabilized ground surface or pavement.

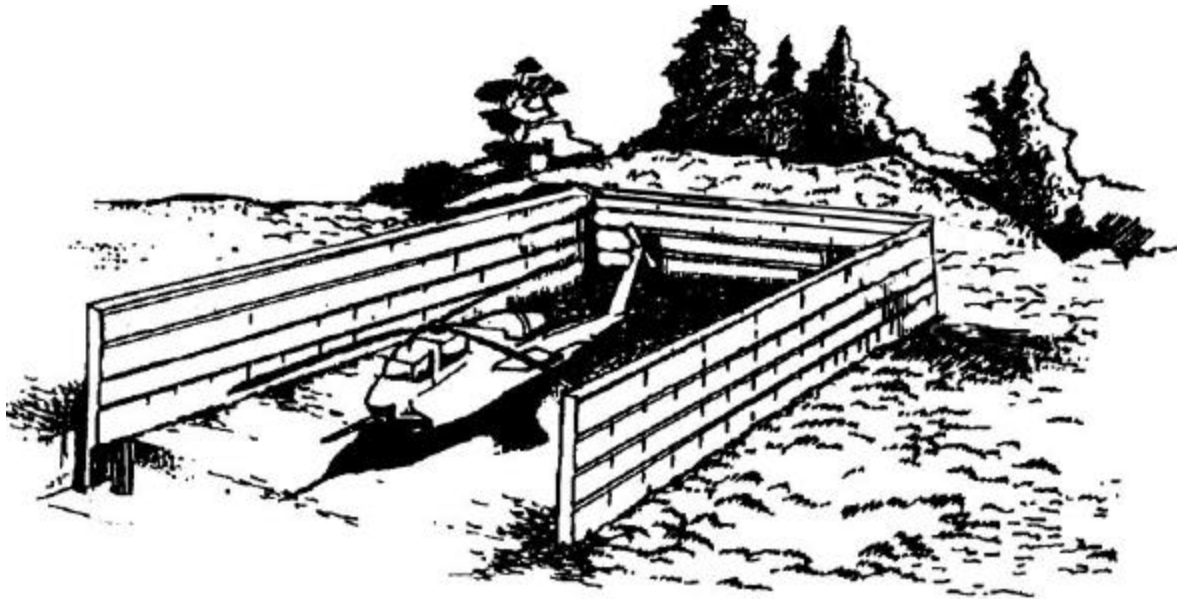
Tires: Tires (figure 24) can be stacked together and filled with sand. They should be at least two rows thick, staggered, and fitted together to prevent gaps between rows. Most tire stacks should have at least one metal post or pole run the height of the tires and buried at least 18 to 24 inches into the ground. For every 3 to 4 feet of height and at the top of the revetment, tie the posts together using heavy gauge wire or banding strap. For longer deployments or when time permits, weld the poles together with steel reinforcing bar and pour concrete into the top tire to cap the tire stack. When using camouflage, provide longer poles on some tire stacks for use with the netting.

Figure 24. Tire Revetment Walls.



Plywood, Corrugated Metal, and Landing Mat Wall: Filled walls may be constructed with: exterior plywood (3/4-inch thickness minimum) (figure 25), corrugated metal siding (26 gauge minimum), or damaged landing mats. Vertical support is provided by wooden support posts (6 x 12 or 2-6 x 6) and bracing (4 x 4 or 2-2 x 4) with tie bolts. The walls are normally limited to approximately 12 inches wide (i.e., the width of the support posts) and filled with sand or compacted soil.

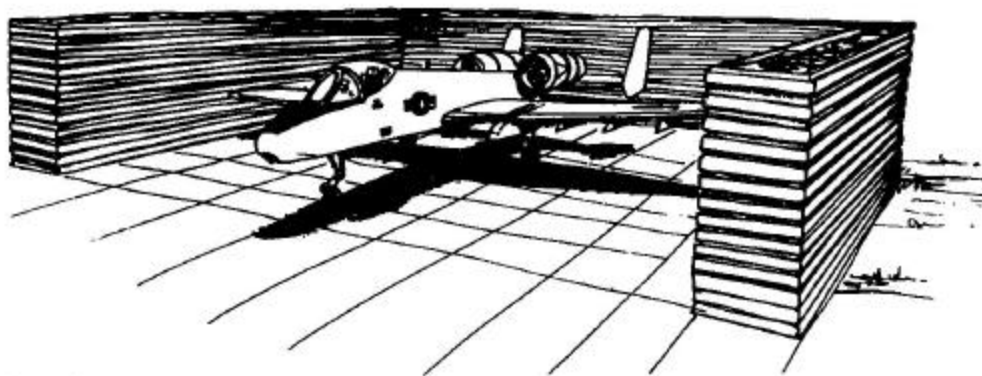
Figure 25. Plywood Walls.



Steel Bin Revetments. There are two steel bin revetments that are logistically supported, the A-1 and B-1 (figure 26) revetments. Both of these systems are pin-connected systems. The bolted-up ARMCO system is no longer logistically supported, but may be found at some overseas locations. The A-1 kit provides a 12-foot high, 62-inch (nominal) wide, 256-foot long revetment, while the B-1 kit provides for a 16-foot high, 82-inch (nominal) wide, 256-foot long revetment. Special instructions are available in AFPAM 10-219 Volume 2 to provide reinforcing of the A-1 kit to allow its use at 15- and 18-foot heights. Due to the very large, concentrated mass of these revetments, metal bin revetments must be installed on a stabilized ground surface or pavement. The cells sections (i.e., two side sections and two cross panels) are assembled in place or can be assembled on the ground and lifted into place with cranes. Bin revetments also should be constructed with:

- A porous lining material or 1/2- to 3/4-inch gravel in the first layer to allow drainage,
- An impervious sheeting material along the sides to prevent soil material from falling out, and
- A waterproof cap at the top to prevent rain intrusion and blowout of the fill.

Figure 26. B-1 Bin Revetment.



Bin revetments, especially metal bin revetments used with aircraft, should be sited to prevent damage to individual assets from incoming weapons, and to prevent propagation between cells of multiple revetments. Propagation is especially a concern for aircraft that are fully loaded with cannon rounds, rockets, missiles, and bombs. These weapons could *cook-off* and detonate or launch when exposed to the extreme heat of an aircraft or fuel system that is burning or detonating near the weapon. By dispersing aircraft (figure 27) such that the cells do not face each other and fuel drains away from other aircraft, propagation can be limited. If dispersal is not possible, such as on an aircraft parking or refueling ramp, then clusters of revetments can be used (figure 28).

Figure 27. Dispersed Bin Revetments.

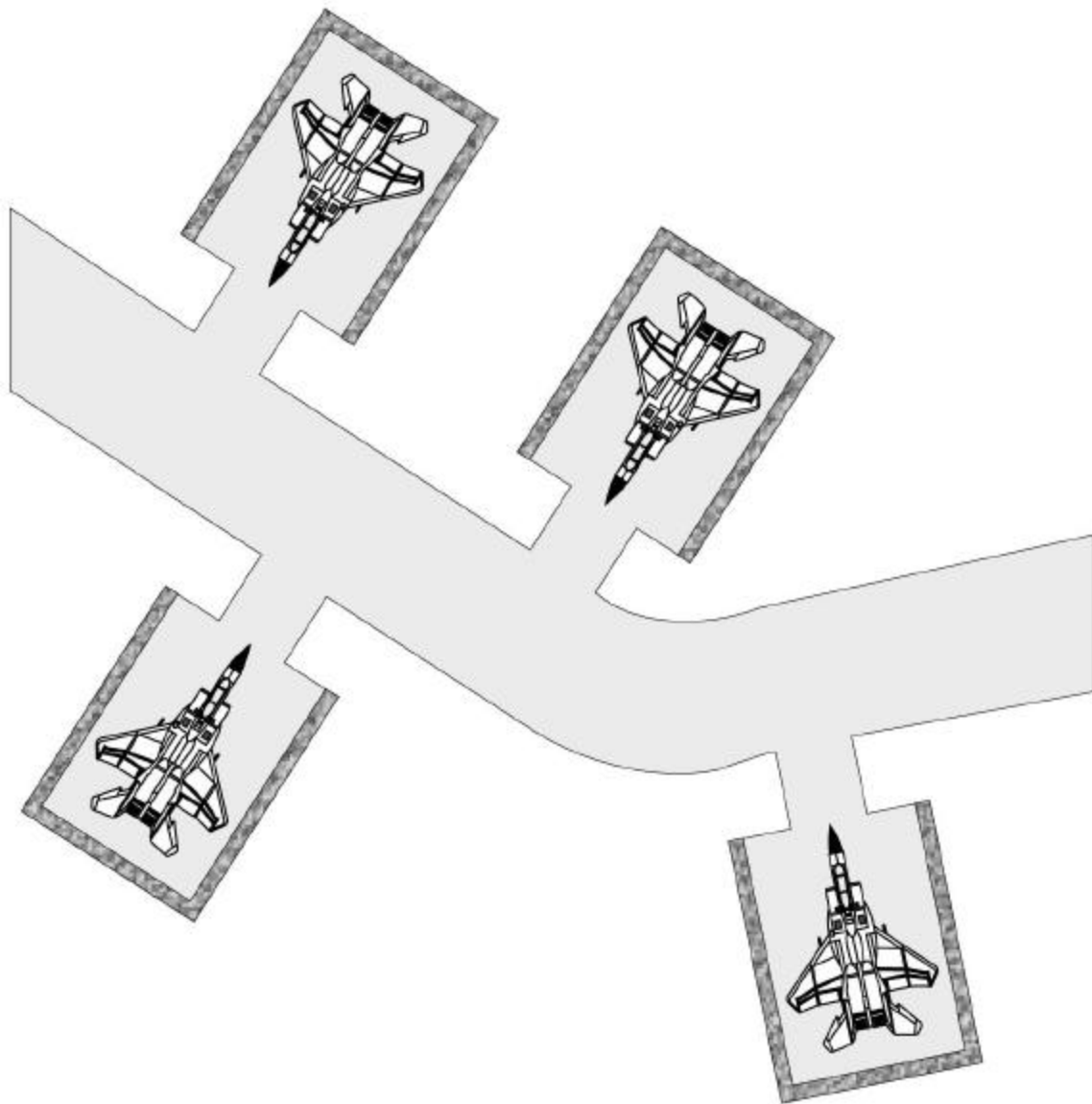
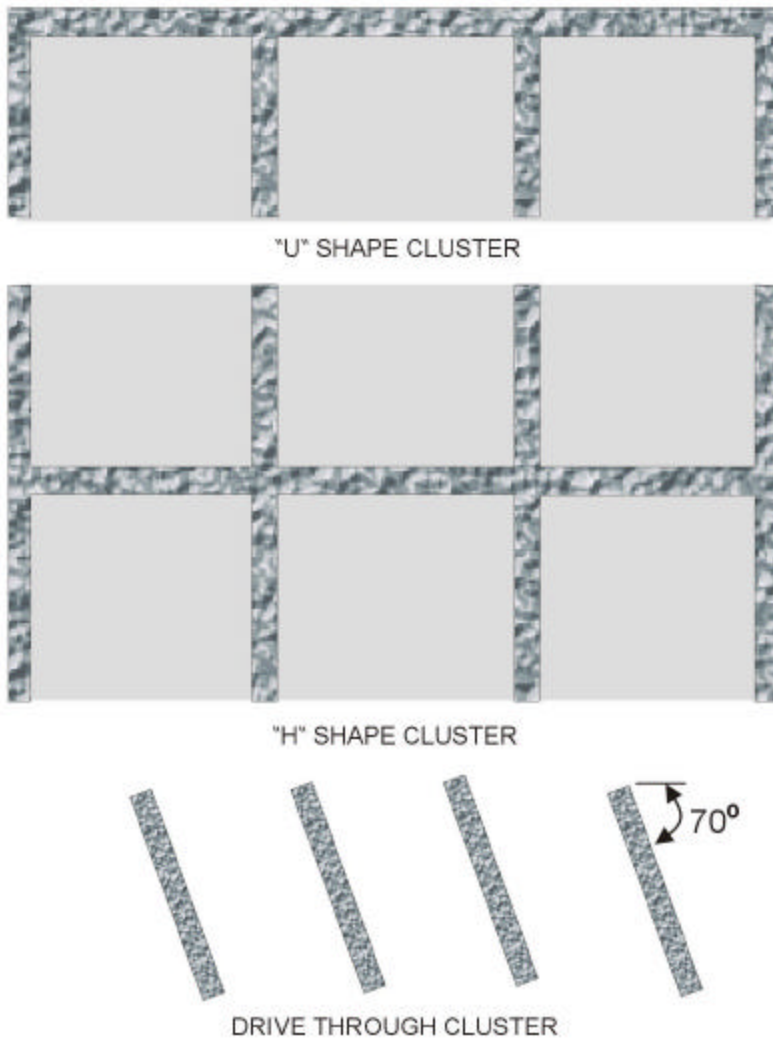


Figure 28. Clustered Bin Revetments.

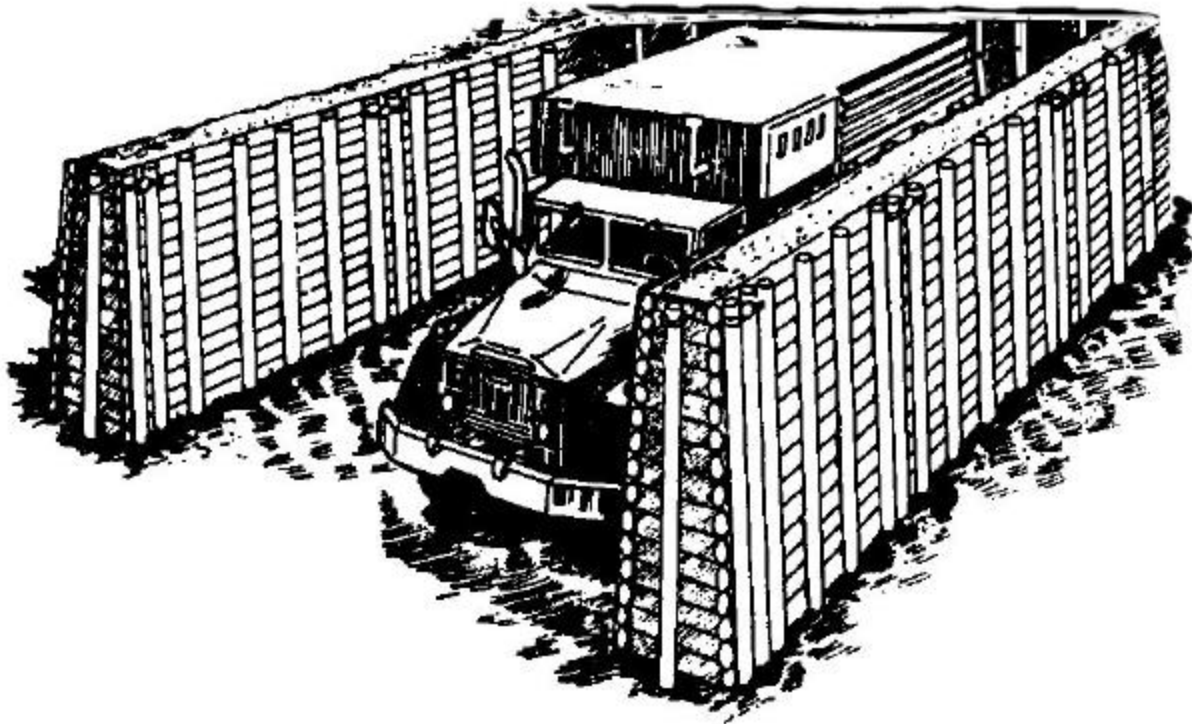


Timber and Lumber Revetments. There is little difference between timber and lumber revetments except the raw materials. They are both built like plywood walls, except that the inside facing material is either saplings or lumber. The facing timbers of the timber revetment are usually 2- to 3-inch sapling trunks laid parallel one on top of the other, fitted together to avoid gaps. The facing lumber of a lumber revetment is a minimum 2-inch thick board or 2 inches of layered plywood sheathing. For a timber revetment (figure 29), the posts are usually 6-inch diameter round timber spaced no more than 2 feet apart, while lumber revetments use 2 x 4 studs spaced about 12 inches apart. The posts are normally set 2 feet into the ground for bracing and have 3 tie cables run between opposite posts. One cable provides a tie at mid-height, while the other two cables are at about 1/6 the height from the top and the bottom respectively. As a minimum, every other post is tied.

The ends of the revetments are blocked with additional posts and timber or lumber; therefore, the minimum width of the revetment can be greater than the plywood wall type revetment. As a minimum, the walls are built in cells every 10 feet. A cross-braced wall is built within the lumber revetment by

using 2 sets of 4 x 4s, set 2 inches apart, to create a slot on the inside of each wall. Then 2-inch thick lumber is stacked in the slot to create a cross-braced wall section. For the timber wall, two sets of the 6-inch diameter posts are set about 3 inches apart on each side of the wall. Cross members are notched and stacked to fit into the facing logs.

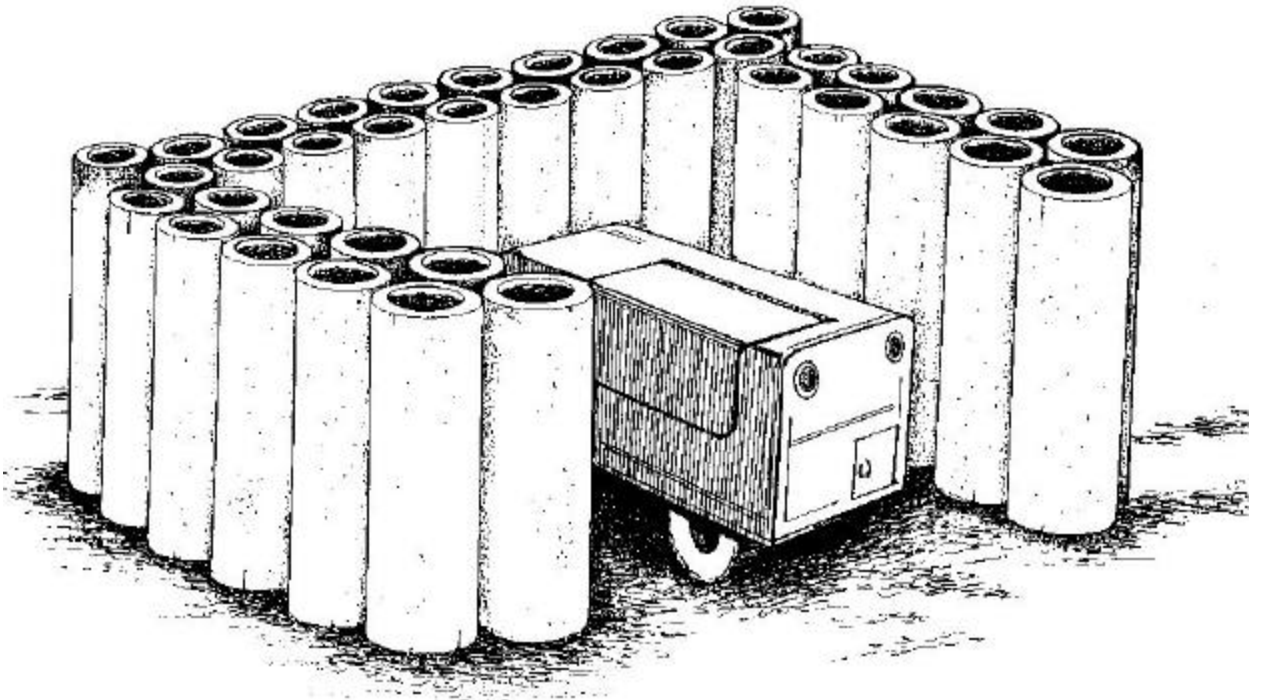
Figure 29. Timber Revetment.



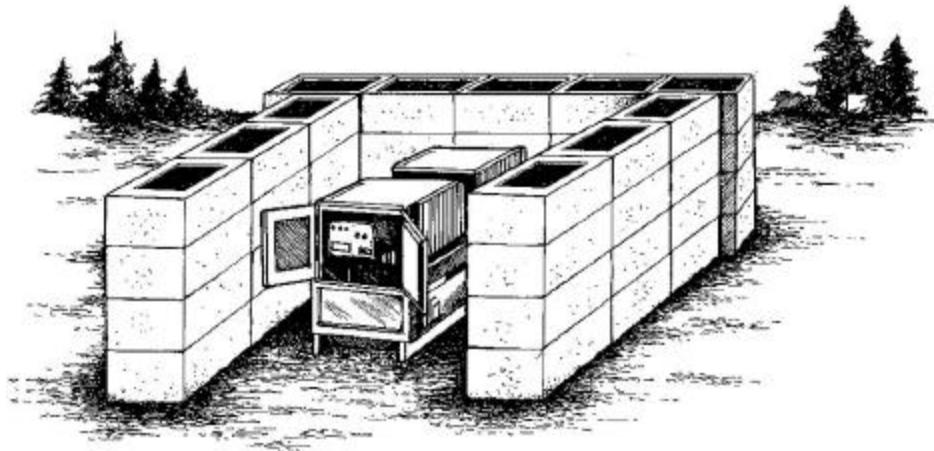
Concrete Culvert Soil Bin. Typical precast concrete culverts come in numerous sizes, but are usually limited to about 2-meter and 6- and 8-foot lengths for ease of handling and to prevent damage during installation. A minimum of a 30-inch (outside diameter) culvert should be used for this type construction. Larger diameter culvert (ranging up to more than a 6-foot diameter) may also be used if available. Install the culverts standing on end, on at least a stabilized ground base, as close as possible together. Most commercially available large culverts normally have bell and spigot or tongue and groove ends. If possible, obtain straight-sided culverts, as they can be placed together vertically, because they do not have flared ends that create a gap between culverts. If the culverts have bell-ends, place the larger bell ends down and fill in the gaps between rows with filled, smaller diameter PVC pipe or concrete culverts.

Use at least two rows of culvert with the culvert joints staggered (figure 30). If available, drive steel dowels or pipes into the ground at the center of each pipe to keep the base of the culverts from moving. Fill all culverts/pipes with dry sand or soil and cap the top of the culverts with at least 10 inches of concrete and a short length of exposed dowel or pipe. Tie the dowels together by welding reinforcing bars to the dowels on each row and between the opposite two adjoining culverts. Do not stack culverts on top of each other -- they should only be used one length high.

Be aware that concrete culverts come in various strengths to resist traffic loads. Some culverts with little traffic loading capacity may have lower quality concrete and less reinforcing, which could make them unsuitable for use.

Figure 30. Concrete Culvert Soil Bin.

Concrete Chamber Soil Bin. Precast concrete chambers for manholes or precast concrete box culverts for drainage under roadways come in many sizes and strengths. Due to the very heavy weight of the stacked concrete chambers and soil fill, these chambers should be installed on at least an 8-inch thick reinforced concrete foundation. The foundation should extend about 6 to 12 inches beyond the edge of the culverts, except the inside portion of the foundation should extend at least 18 inches beyond the edge of the culverts to prevent overturning from blast forces. The precast manhole chambers (figure 31) vary from 3- to 8-foot sections and are less reinforced against loading than roadway box culverts, which vary from 3- to 12-foot sections.

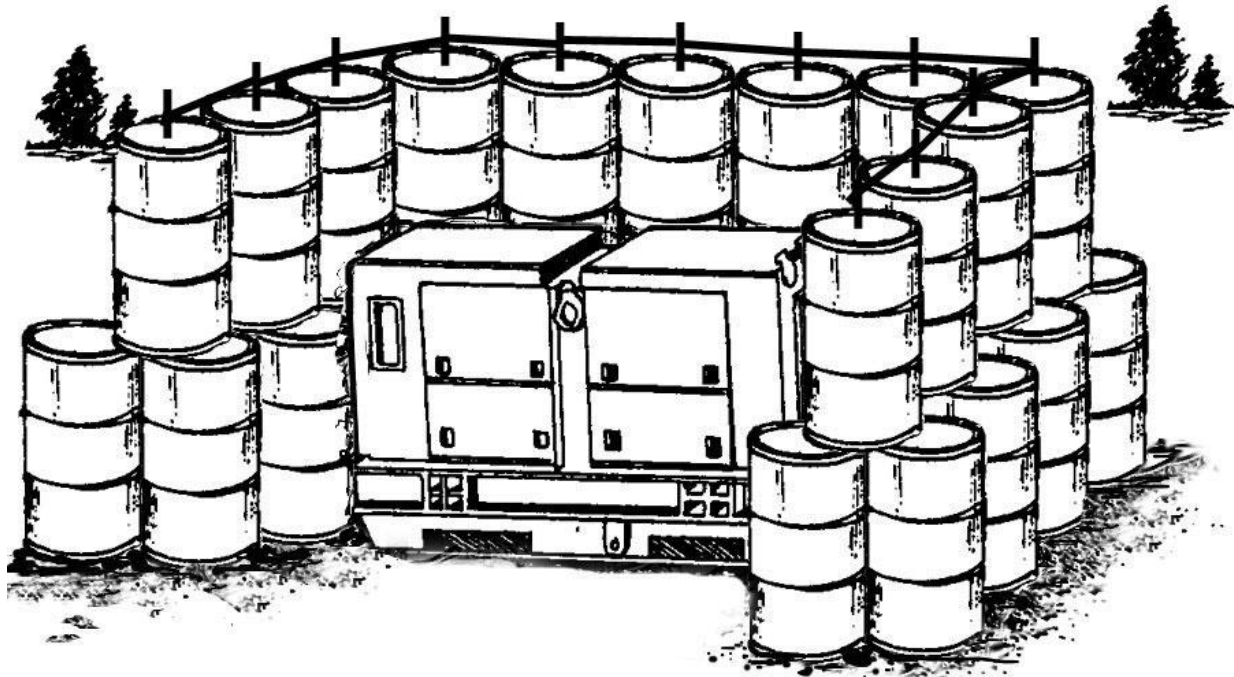
Figure 31. Concrete Chamber Soil Bin.

As the units are meant to be joined together at their ends, manufacturers may provide an attachment system. If designing for blast protection, as a minimum, use 1/2-inch diameter bolts to bolt together each adjoining chamber and also bolt together each chamber in a stack by using at least two- 2 x 3/8-inch steel straps. Locate the straps on the inside face of the chambers, on the side of the chambers that will be exposed to the blast. Extend the straps from the middle of the top chamber down to the middle of the bottom chamber. For higher revetments or revetments with narrower walls, a poured concrete base may be required. For shorter walls on prepared soil bases, the lower chamber may be partially recessed into the soil. The bottom chamber should also be fastened to the foundation with 1/2-inch diameter bolts and the same type 2 x 3/8-inch strap bent into an L-shaped anchor.

Fill each chamber with sand and cap the top chambers with an impervious material. Higher strength, reinforced chambers and box culverts can provide multiple-attack protection.

55-Gallon Drum Soil Bin (figure 32). The standard dimension (nominal 23-inch diameter by 36-inch high) drums are run side-by-side and placed on end in staggered rows around the asset to be protected. Subsequent levels of rows are stacked on end on the previous rows by setting the upper row back 1/2 drum width from the previous drums. A 6-foot tall revetment has one row of drums supported by two rows of drums. Higher and/or wider walls can be constructed by using additional rows. A 2-level wall with three rows of drums can support two rows of drums, while 4-rows can support 3 levels (9-foot high) of drums and provide an upper row 2 drums wide. This is about the largest feasible structure that can be built without providing much more reinforcement.

Figure 32. 55-Gallon Drum Wall.

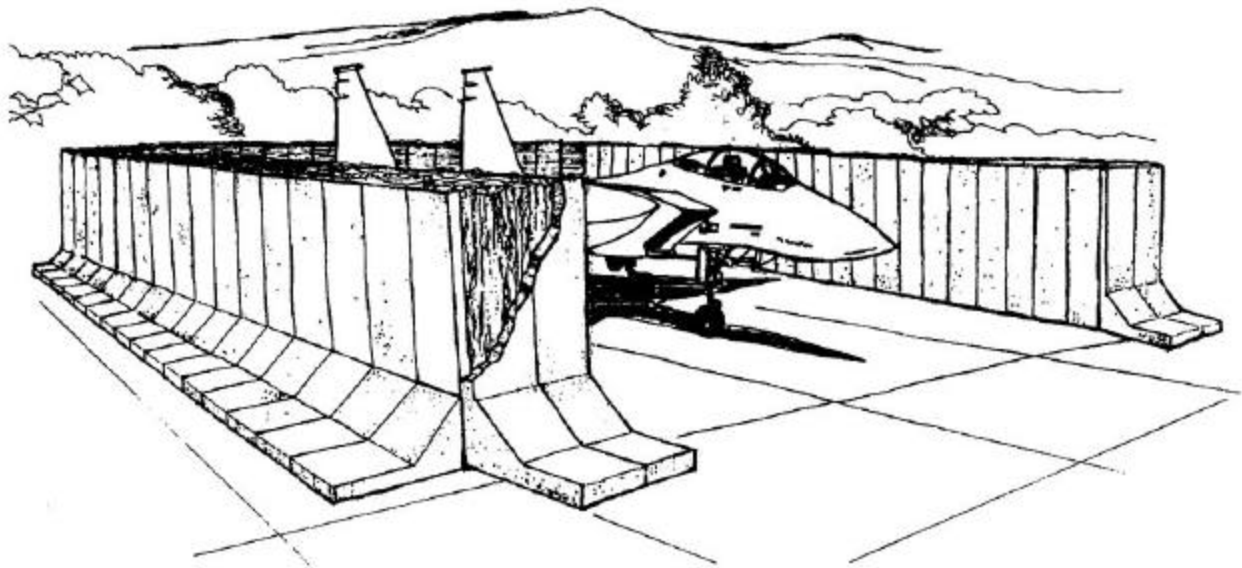


The shape and size required for the revetment makes it difficult to create any hard and fast standard construction layouts or methods for this system. However, as a minimum, fill each drum with dry sand or compacted soil and cap each drum level with 6 to 8 inches of concrete. Use dowels (using dowels, pipe, or reinforcing bar) between the stabilized ground base and the bottom layer of drums to prevent sideways displacement from blast. Also insert dowels into each concrete cap, positioning the dowels to fit inside the drum above it on the next level. When there are two rows of drums in the top row, place a dowel in

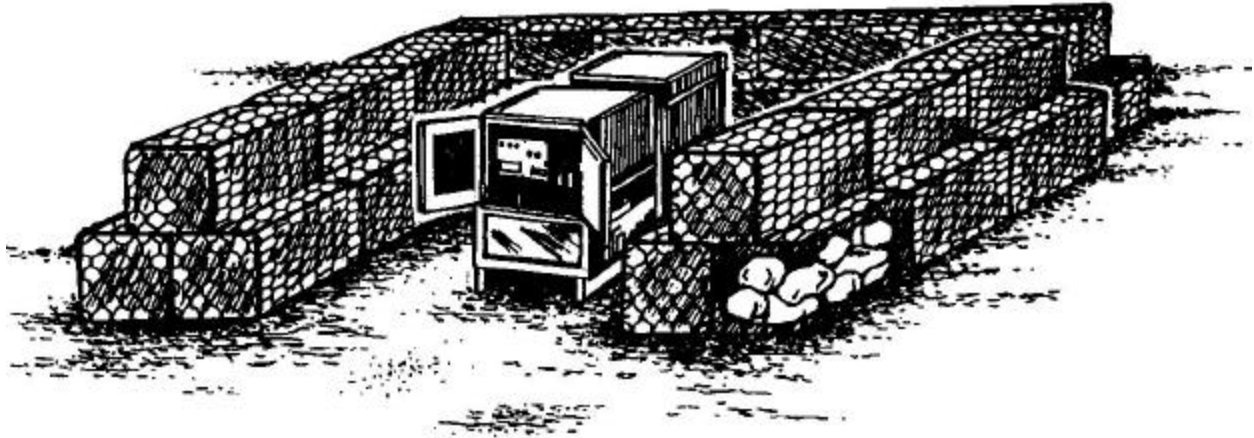
the center of each drum cap of concrete and spot weld the dowel to reinforcing bars run along each row and between each adjoining drum. If possible, spot weld the top of each drum where it contacts the bottom of the next row.

Concrete Revetment Soil Bin. Concrete revetments, such as the four-meter aircraft revetment (figure 33), can be stacked in parallel rows. The rows are separated by the width of the base leg extension, to provide a 76-inch thick by 13-foot high soil bin. Because the walls and edges do not match or interlock perfectly, soil can seep out of any gaps. Line the walls of the revetment with a geotextile fabric or plastic liner to prevent soil loss. Cap the top of the revetment with an impervious layer. These revetments align best when placed on smooth pavement.

Figure 33. Concrete Revetment Soil Bin.

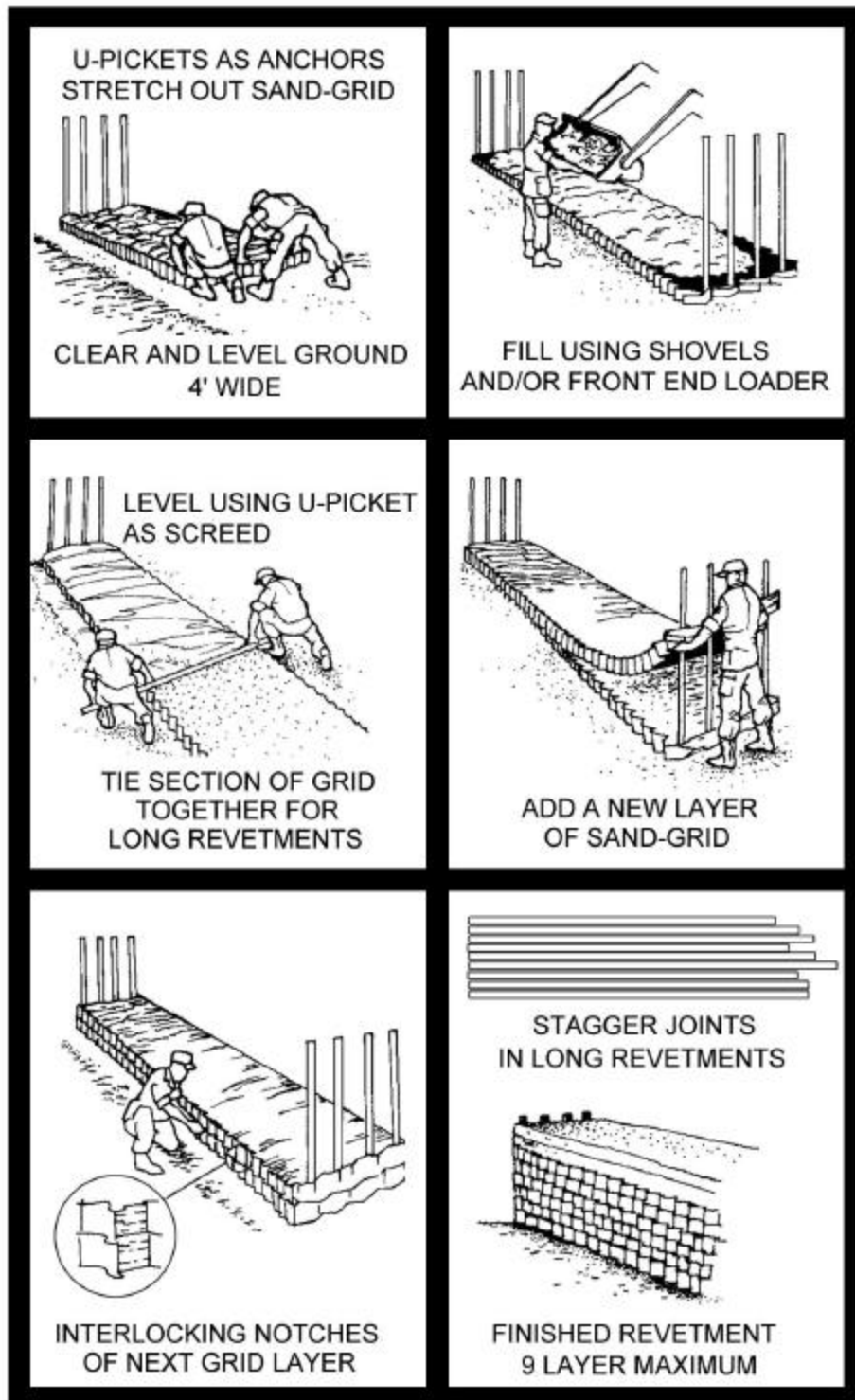


Gabion. A wire mesh cage called a gabion (figure 34) is filled with rock or concrete rubble that is larger than the dimensions of the wire mesh. The wire cage is rectangular in shape, about the size of a bale of hay, and has a wire mesh lid fastened with wire. The gabions are laid end to end and next to each other to form layers. Adjacent gabions are tied to each other with wire for reinforcement. Additional gabions can be stacked on lower layers and filled. Stagger the end joints and slope the stacked gabions as required for stability; set each layer back about 1/4 to 1/3 the width of a basket from the previous layer. All layers are wired to each other and any adjacent layer. While gabions are effective for stopping blast and fragments, be careful when using them. When hit by an explosive warhead, they can cause additional lethal shrapnel, causing even more serious injuries to nearby personnel.

Figure 34. Rock Filled Gabion Walls.

Sand Grid Sand grids are prefabricated, expanding plastic forms that have honeycomb shaped cells, which will confine sand, gravel, and soil. As originally configured, the grids (figure 35) were 38 inches wide, 8 inches high, and 20 feet long when expanded; they were 55 inches wide by 8 inches high by 4 inches long when packaged. Other sizes are available in varying depths, lengths, and widths (up to 8 feet wide). The ability to stack sand grids will depend on which grids are available at the deployment site. Newer sand grids are made with a notched grid that provides a lapped joint between layers.

Figure 35. Sand Grid Revetment.



The grids are laid out over metal pickets at each end of the grid and stacked one layer upon the next. The mid-revetment joints should be staggered for long revetments. The maximum freestanding height for a 38-inch wide revetment is 8 feet, although 9 layers (i.e., 6foot high) is recommended for use with standard picket anchors without adding additional pickets. For additional height, lower rows should be

laid with either wider sand grids or additional rows of sand grids run parallel, face to face. Middle and upper rows should be made with narrower sand grids. Make sure that all rows have anchor pickets or additional intermediate pickets that extend to several adjoining layers. If rows are run parallel, face to face, then tie the rows together for stability. To prevent erosion and soil loss with sand grids that are not notched, a geotextile fabric should be placed between each layer of sand grid. Cover the top layer with impervious sheeting and sandbags.

Wire Frame, Fabric Lined Containers/Concertainers (figure 36). There are several manufacturers of wire frame, fabric lined containers that have been tested as revetments. This system is basically a very large, (high strength geotextile) fabric lined row of cells without a top or bottom. The units are collapsible and unfold into open, square shaped adjoining cells. Depending on the system ordered, the cells vary from as small as 2 x 2 x 2 x 4 feet (Length x Width x Height x Total Length) up to 7 x 7 x 7.25 x 91 feet (Length x Width x Height x Total Length). The systems are spread out and filled with soil by front-end loaders, cranes with buckets, or conveyor systems.

The revetment systems can be fastened together with various manufacturer-developed systems or with wire or tie wraps. They can be run parallel (face to face) to form various sized bases. These revetments should also be fastened together between layers.

Figure 36. Wire Frame, Fabric-Lined Container/Concertainer Revetment.



Some manufacturer's attachment systems may allow several rows and layers to be run with even faces and/or butted joints. If the revetment systems are not designed for this, then stagger the joints between rows and layers. For stability, especially with larger revetments, build using a pyramid shape. When several layers use the same width of cells, the layers should be set back inward by having at least every fourth layer for small cells and every third layer for larger cells set back between 1/4 to 1/2 a cell width.

The picture on the right in figure 36 shows a Concertainer system located behind a bomb crater. It demonstrated that with proper pyramid layered construction, the system has excellent stability even after being hit by a nearby bomb blast and fragmentation.

If this system is going to be used near a flightline, then the top of the exposed soil surfaces should be covered. Use a geotextile fabric, impervious sheets, and/or sandbags to prevent erosion and jet blast from throwing out sand and soil fill.

Berm and Revetment:

Berm against a Retaining Wall. By placing a berm against a retaining wall, the protective berm can be placed much closer to the asset. If precast concrete retaining walls are not available, expedient retaining walls can be built using thin bin revetments built with plywood, corrugated metal, or landing mats. The retaining walls should be no more than 11 feet high.

One sided retaining walls may also be built with 6 x 12 posts, 4 x 4 horizontal runners, and a sheathing surface of at least 1-1/2 inches of plywood, heavier gauge (16 gauge or better) corrugated metal, or landing mats. Posts should be set at least 4 feet into the ground and no more than 4 feet apart. On the berm side of the posts, starting at ground level, nail horizontal runners to the posts at no more than 2 feet apart for each runner. Fill in between the 4 x 4 runners by nailing short sections of 4 x 4 to the posts between runners. Fasten the plywood or metal sheathing to the 4 x 4s.

There are two ways to anchor the retaining walls to each post. The more protected way is to anchor each post at about 2/3 the height of the berm to deadman anchors that will be located under the berm material (figure 37). Use at least 3/8-inch guy cable run on a 3:1 slope (Vertical to Horizontal) down to the deadman anchor. The alternative method is to anchor each post to three individual deadman anchors placed along the face of the berm (figure 38). While this can help stabilize the berm, it exposes the anchors to more damage from blast.

Figure 37. Berm against a Retaining Wall.

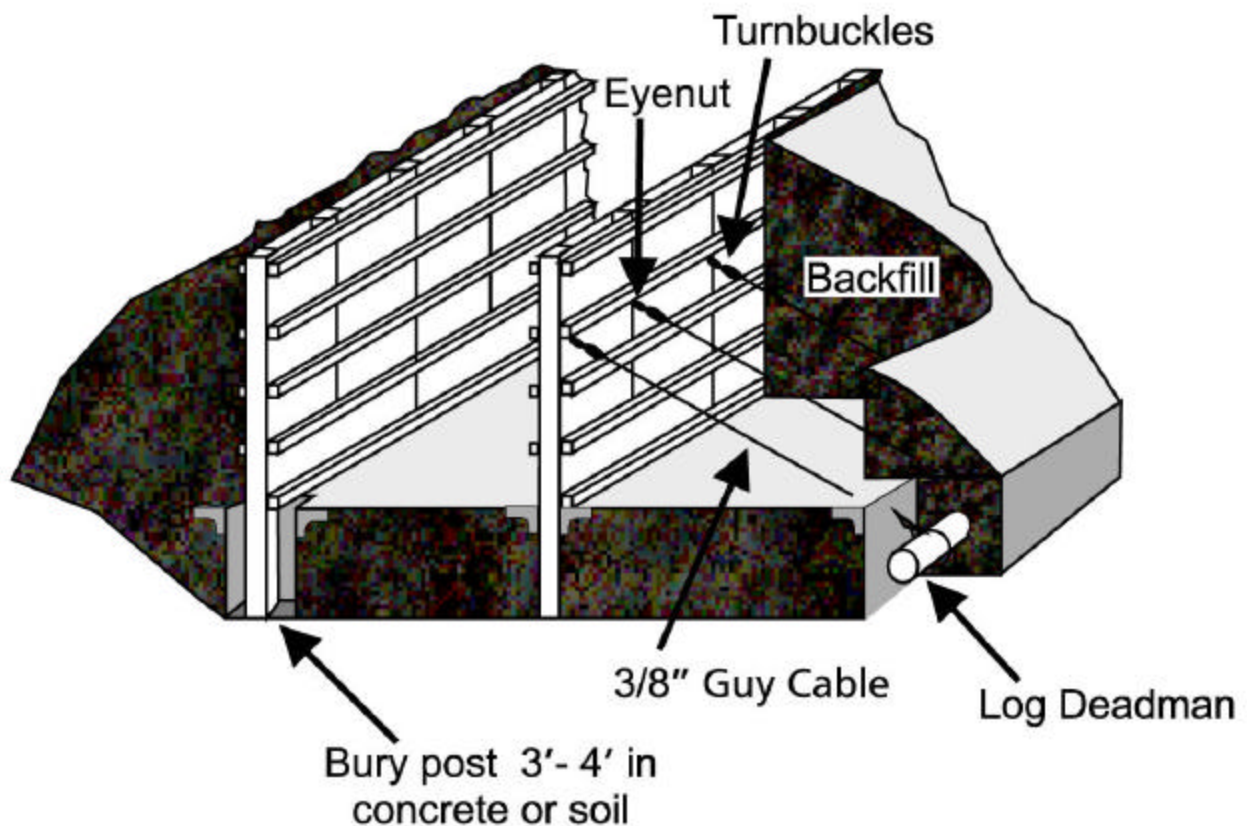
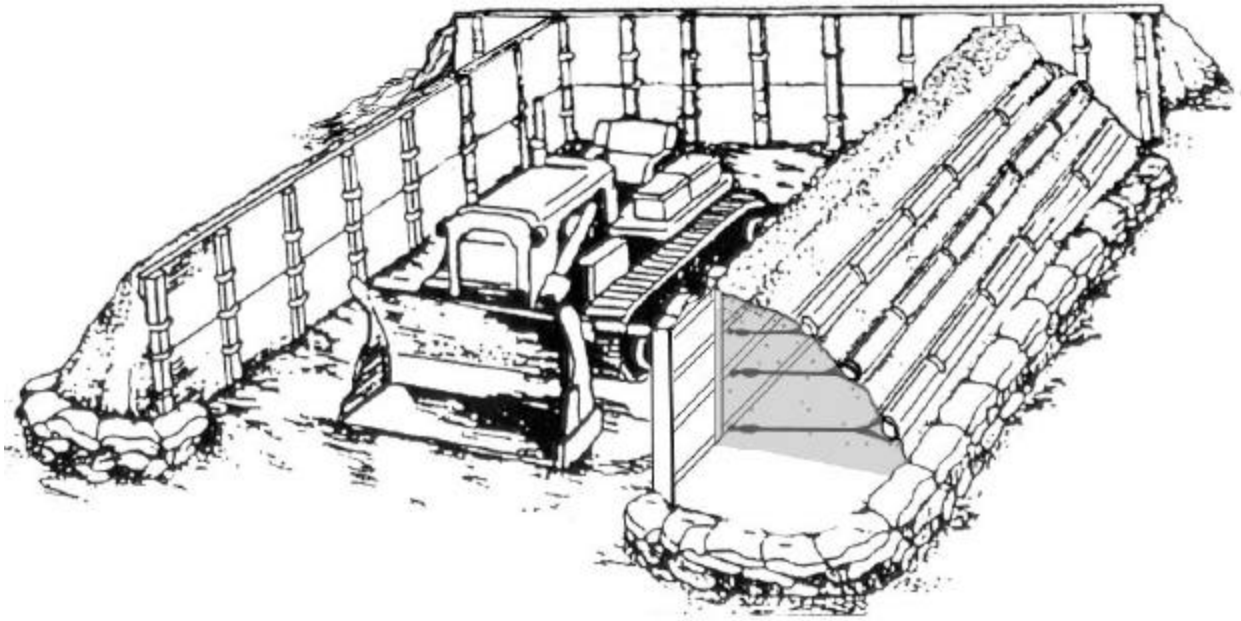
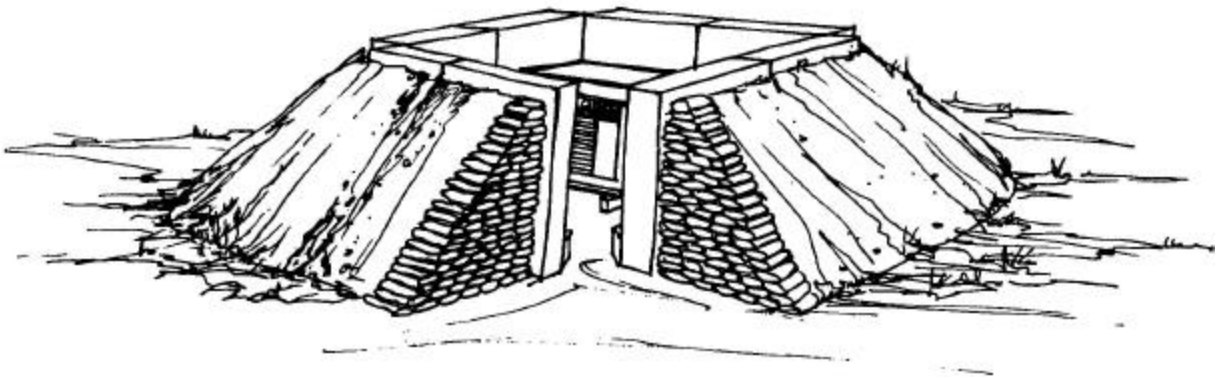


Figure 38. Partially Braced Berm against a Retaining Wall.



Berm against a Revetment. Just as with berms against a retaining wall, berms against a revetment provide much greater protection from blast and fragmentation. Revetments may be any of the freestanding revetment types that do not require additional support, such as the precast concrete Bitburg revetment (figure 39) or timber and lumber revetments.

Figure 39. Berm against a Revetment



Shields and Standoffs: When unprotected assets and personnel require protection from fragmentation and small arms projectiles, but there is not enough time or resources to provide a full size revetment or berm with large amounts of fill material, then a shield may be used. Various structural or non-rigid materials may be used as a shield to improve protection from fragmentation.

If a position is hardened against fragmentation, but can not withstand the direct hit of a weapon, then a shield can be used to intercept and explode incoming rounds. When a shield is used this way, it is called a "standoff". Standoffs can be used to protect a hardened position from specific weapons systems or repeated impacts from weapons. In many cases, the hardened position is a fighting position. If the occupants were exposed to direct

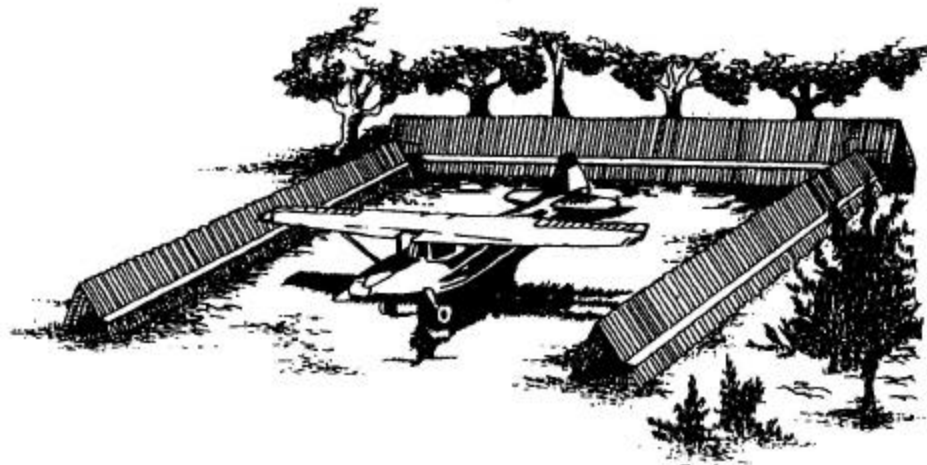
blast, they would not be able to react for long periods of time due to disorientation and deafness. By lessening the blast with a standoff, personnel are able to keep functioning. The distance the shield is installed away from the fighting position (or other hardened structure) is the *standoff distance* and depends on the weapons, warheads, types of fuzes, and the amount of protection required by the hardened position. In some cases, this distance may be as close as 10 feet.

Some of the materials, such as narrow log walls and fencing, are effective against direct-fired weapons with contact fuzes. The weapons detonate on contact with the standoff structure and the hardened position is hit with less blast and many fewer fragments. Stronger standoffs are required to defeat direct-fired weapons with delayed fuzes. In this case, the standoff structure must be strong enough to destroy the warhead or deflect it away from the hardened structure, such that the delayed explosion has less effect on the hardened position. Standoffs may also require camouflage to prevent them from being detected and giving away the location of a defensive fighting position or other asset. Following are various shields and standoffs.

Landing Mat Shield For protection against fragmentation from smaller weapons, steel or aluminum panels can be used to provide a limited degree of protection, even without fill material. Obsolete steel M8A1 landing mats (figure 40) previously stockpiled or used at a base, damaged AM-2 aluminum mats, or heavier gauge (i.e., 10 or 12 gauge or thicker) corrugated steel panels can be used. While landing mats were manufactured in 6- or 12-foot lengths, corrugated steel panels come in many lengths and widths. Depending on the length of the panels available, 6- to 12-foot lengths of panel can be set up in an "A" shaped shield wall around an asset. Fastening for the panels is usually by welding for steel and bolting for aluminum.

The walls are constructed to stand up and lean toward each other at about a 2:1 (Vertical to Horizontal) slope. Fasten the tops of the panels together by either welding the steel panels or bolting the aluminum panels together with an angle iron. Likewise, the sides of the individual panels are fastened, bolted, or welded together along their long edges. The shield walls are also held together by welding or bolting steel angles, pipe, or 2 x 3/8-inch straps run parallel to the wall about 1/3 up the panels. If possible, cross brace the panels by welding together a cross piece every 10 to 12 feet. Anchor the shield wall with stakes or pipes to prevent overturning from high winds or blast effects.

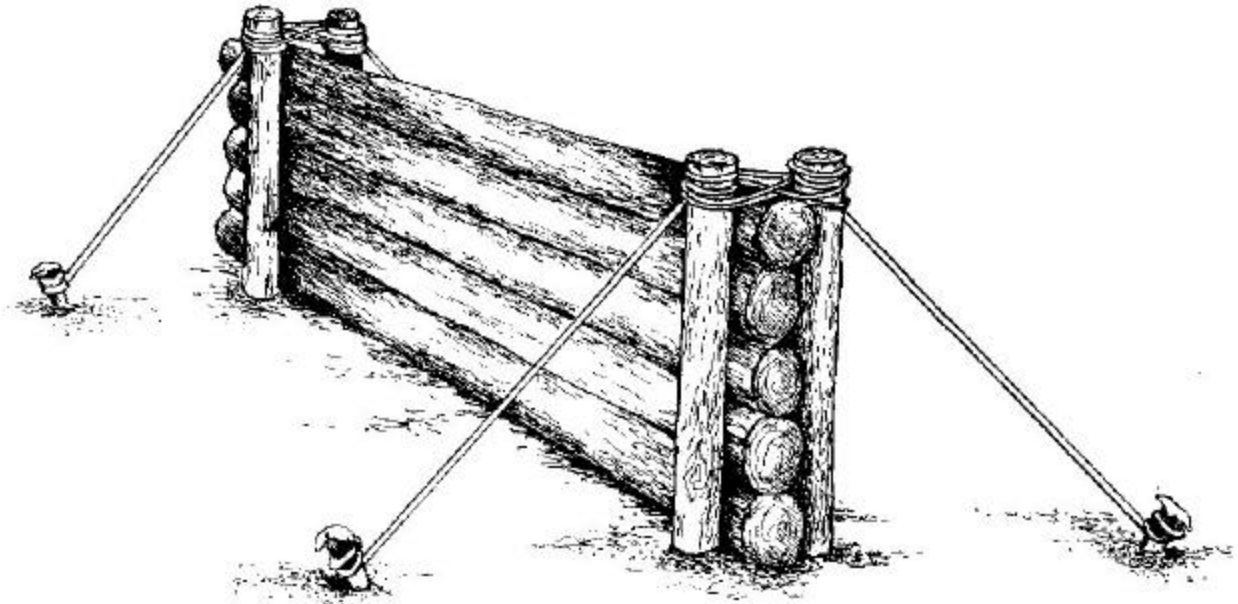
Figure 40. Landing Mat Shield.



Log or Lumber Wall Standoff. This type of standoff construction consists of short sections of 4-to 6-inch logs (figure 41) or lumber that are stacked together between posts of the same size as the wall sections. The posts are fastened together at the top and further held in place by guy wires or ropes fastened to stakes. Several 10 to 12 foot sections of standoff should be constructed toward the front of

the position and placed in a staggered fashion rather than building one long wall which could be destroyed by one detonation.

Figure 41. Log Wall Standoff.



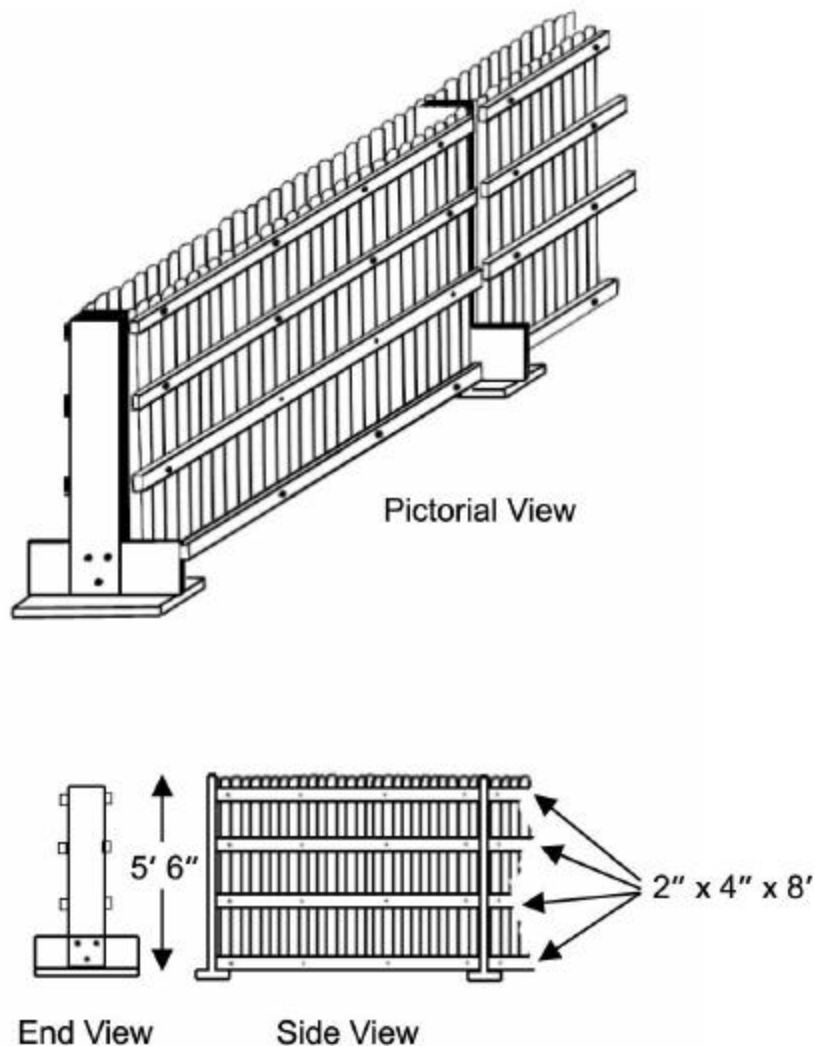
Sheathing Standoffs. A sheathing material may be used to defeat some weapons and fuses. There are numerous sheathing materials that can be used: 1/2- to 2-1/2-inch thick layers of plywood or lumber, heavy gauge corrugated metal sheets, or a combination of plywood and corrugated metal sheets. The sheathing is mounted on 4 x 4 or 4 x 6 posts or 2- to 3-inch diameter metal pipe. The supporting posts or pipes are placed at the ends and middle of 8 to 10 foot sections (depending on the length) of sheathing material. The support posts or pipes are buried about 2 feet into the ground and the wall is braced with guy wires at each end and the middle. Instead of using guy wires, braces may be used to support the wall. Cant the front face of the wall at an 8:1 to 10:1 (Vertical to Horizontal) slope away from the side facing incoming weapons; the face slope can be varied to resist winds. Install 2 x 6 braces on the back face at the ends and middle of the wall sections. Attach the braces to the top of the support posts and run them to the ground at a 1:1 slope (Vertical to Horizontal). Set the braces and posts at least 2 feet into the ground to resist pullout.

Portable Plywood or Corrugated Metal Wall (figure 42) Shields: These portable shields have relatively thin walls and are built using similar designs and structural materials as the bin type walls previously discussed. The shield walls are parallel, usually only about a foot apart, and are filled with soil or sand after the walls are moved into position. The ends of the wall are inverted "T"-sections. The vertical portion of the T-sections are made with two layers of 2 x 12 boards or cut plywood; the T-section is 5.5 feet high by 3 feet wide. The bottom of the bin section is also lined with a 2 x 12 fastened into place to help prevent the fill from leaking from the walls. The walls are kept relatively low in height and made in 8-foot sections to keep them from being blown over by nearby explosive blasts. These walls provide additional protection from blast and fragmentation compared to sheathing standoffs. Poles or 2 x 4 lumber are typically used as parallel runners along the wall at the top, bottom, and intermediate on the wall to brace the sheathing. The runners and shielding material are held together with ties or bolts. Unlike standoffs, these portable wall sections are butted and fastened together. Additional 2 x 12 boards

may be fastened under the T-sections as bearing plates to prevent settling of the walls into the ground; the fastened bearing plates may be weighted down with sandbags to provide additional resistance to overturning from nearby blasts.

Precast or Cast-in-Place Concrete Shields. Precast concrete slabs, revetments, and retaining wall sections may be used alone as a shield to provide protection against fragmentation and small arms projectiles. Cast-in-place structures may also be used if time and materials permit. The precast structures may be installed either freestanding or partially buried in front of structures or assets. They are designed to withstand a first hit. If multiple attack and/or multiple hit capability is required, then the units should be portable and freestanding to allow more rapid replacement.

Figure 42. Corrugated Metal Wall Shield.



Depending on the placement of the shield, the weapons to be defeated, and the concrete's strength, thickness, and reinforcing, the concrete structure may also be used as a sacrificial panel or standoff for use against contact fuzes, as well as some delayed fuzes. The precast shields used as sacrificial panels may be as thin as 6 inches and have less reinforcing steel (i.e., standard #4 rebar at 12 inches on center,

both directions). Stronger shields built like revetments may be up to 12 inches thick and have more reinforcing (i.e., high strength #5 rebar at 6 to 10 inches on center).

As with the designs for portable revetments, the designs for expedient precast shields and standoffs are found in AFPAM 10-219, Volume 2. Prior to a deployment, material availability and possible design choices should be reviewed. If these concrete systems are feasible for use, then the designs should be copied or downloaded for use at the deployment site.

Plastic Armor Shield Paving asphalt can be used to form panels for protection from small arms fire. Forms are used to create two 2- by 4-foot panels of asphalt about 2 inches thick. When lined with steel, a four-inch thickness of panel is adequate to protect against mortar blasts from 5 feet away.

To construct **bare asphalt panels**, construct an 8-foot long by 2-foot wide frame by welding 2-1/2-inch steel angles together such that a flange is run inward along the frame. Also weld two steel angles back to back; locate this section midway on the 8-foot side of the frame and weld it to the frame to form a mold for 2 panels. Place a layer of sheet steel into each of the two 2- by 4-foot frame openings so that they are resting on the lower flanges. Spray the surfaces with oil and lay hot mix asphalt with a coarse (3/8- to 3/4-inch road mix) into the frame. If using only a hand tamp, use about 1-inch lifts to create the 2-inch thick panels. If a plate vibrator is available, 2- to 2-1/4-inch lifts are possible. If available, use small cell geotextile paving grid material sandwiched between finish lifts; leave about 4 inches of the mesh material sticking out of the mold on the long sides. When compacted and fully cured, remove the asphalt panels from the form. Use the mesh grid as lifting and fastening handles for the panels. Since these are not structural panels, they need to be placed between metal or plywood walls to provide adequate protection.

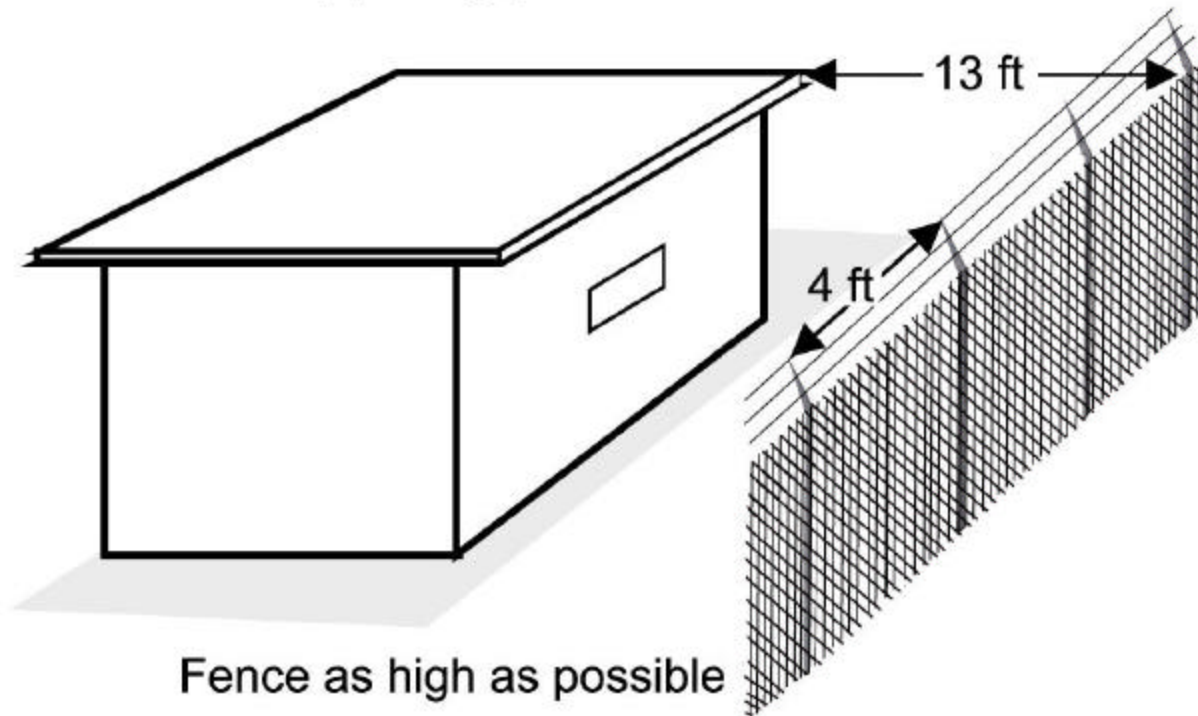
To construct **steel lined, metal framed asphalt panels**, use 2-inch channels (either preformed or formed from 16-gauge sheet steel) to form the edges of a 8-foot long by 2-foot wide frame. Rivet 16-gauge gusset plates at all joints and then cover one face with 16-gauge sheet steel, fastening the sheet steel to the 2-inch channel framework. As with the bare asphalt panels, place and compact asphalt into the frame, except do not oil the frame. When the asphalt has been compacted, cover the remaining face with 16-gauge sheet steel and fasten to the 2-inch channel frame. Since these panels are structural, they can be fastened to posts and framework to create wall sections such as with portable walls. A 4-inch thick panel can also be constructed by using 4-inch channels in place of the 2-inch channels and placing the asphalt in several lifts.

Fencing and other Flexible Standoffs. When a standoff is required, but the protected facility needs visibility for observation purposes, then chain link fencing (figure 43), expanded metal lath, or woven or welded wire cloth are useful in providing standoff protection. These systems will allow more fragmentation and blast to reach a hardened position than does a heavier, more rigid standoff. The wider weave of chain link fencing may also require two or three thicknesses of fence fabric to ensure detonation of the fuze. Likewise, construction type expanded metal lath may also require three layers due to its general lack of strength. High strength metal lath and larger diameter welded or woven wire fabric used for security cages and screens may provide adequate protection with only 1 or 2 layers.

Use metal tie-wires to anchor the fabric to standard (2-1/2-inch diameter) metal poles used for chain link security fences. Place the poles at no more than 4 feet on center. If possible, set the poles 2 feet deep in concrete for fabric up to 8 feet high. Increase the buried depth of the pole for higher fabric. If concrete is not available, then set the poles at least 2 feet into the soil and use wire cable and pickets or deadman to anchor every other pole. Anchor the cable at about 2/3 the height of the pole and an equal length away from the pole.

Figure 43. Fencing Used as Standoff.

Two thicknesses of chain link fence attached to supporting posts on 4 foot centers



OBSTACLES.

Functions. Obstacles can be used to disrupt, turn, fix, or block an opposing force. An explanation of these functions follows.

Disrupt. Use obstacles to break up a formation of an assaulting force, which will then allow attacks on the leadership or exposed individual members.

Turn. Use obstacles to move and manipulate the opposing force into a position that will allow greater firepower to be used. Obstacles would cause or encourage movement in a desired direction, split up a formation, channelize approaching personnel, or expose the opposing force's flanks to attack.

Fix. Use obstacles to slow or hold the opposing force in a specific area long enough for them to be attacked. This function may also be to hold the enemy long enough in place to allow base forces to disengage and move to another location.

Block. Use numerous obstacles employed in depth with integrated firepower to prevent the opposing force from advancing along a specific avenue of approach. The obstacles and firepower establish a limit to further advancement.

Obstacles should make it difficult for an opposing force to bypass or pass obstacles without taking casualties. By creating numerous obstacles in depth, the opposing force can be worn down. However, the obstacles should not be used in any obvious pattern, as this could lead an opposing force to determine where security forces are located.

Experience has shown that defending units should concentrate more of their efforts on determining locations for obstacle groups that will create more effective engagement areas for their fighting positions.

There are basically two types of obstacles that are used against larger opposing forces -- existing and reinforcing obstacles.

Existing Obstacles. Existing obstacles are those natural features of terrain that restrict movement. Security forces should be positioned in fighting positions that are unobservable by the opposing force, allow overlapping fields of fire, and are difficult to bypass. Existing obstacles include:

Steep slopes. Steep slopes can stop different types of vehicles. The ability to climb a slope can be further affected by ruts, brush, felled trees, and the condition of the slope materials.

Escarments. Vertical or near-vertical 1-1/2-meter high cuts in slopes or walls can stop vehicles. To get past the vertical surface requires knocking them down. Thick rock walls, railroad embankments, and steep fills along highways are examples of escarpments that can be used.

Ravines, gullies, and ditches. These obstacles stop most wheeled vehicles. However, these obstacles should be over 5 meters wide to be effective against tracked vehicles.

Rivers, streams, and canals. An enemy force must find a fordable shallow crossing, rely on special means for deepwater fording, or find an elevated crossing. The width and depth of the water, the water velocity, and the condition of the banks and the bottom of the water determine the ease of crossing by shallow or deepwater fording.

Swamps and marshes. These natural conditions are effective obstacles against the mobility of personnel and all types of vehicles when there is either no firm ground or the submerged ground is more than a meter below the water surface.

Snow. Snow 1 meter or deeper is a major obstacle to personnel and vehicles.

Trees. Heavy stands of trees that are 8 inches or more in diameter and spaced less than 20 feet apart will build up into an obstacle when tracked vehicles attempt to push them over and force their way through.

Built-up areas. Although not a natural feature, existing built-up areas by their nature channelize and restrict movement. They fall between the classification of existing and reinforcing obstacles. Built-up areas are normally not used for beddown of personnel deployed to overseas locations. However, they may exist nearby and could be used as a staging area for offensive forces to attack the base. Base or other security forces may use built-up areas as an area suitable for the defense of part of the base. These areas can be further enhanced as obstacles by cratering streets, demolishing walls, and overturning or derailing heavy vehicles or railroad cars. Roadblocks can be built from rubble or construction materials. The use of barbed wire and mines are effective against personnel and vehicles. Many reinforcing obstacles are suitable for use in built-up areas.

Reinforcing Obstacles. Reinforcing obstacles are obstacles that tie together, strengthen, or extend existing obstacles. These may be: created by moving existing materials or obstacles with equipment or explosives, constructed in place, or preconstructed and moved into place. Reinforcing obstacles should make maximum use of the existing terrain and its obstacles. Except for wire entanglements, most reinforcing obstacles will require Civil Engineer support. Reinforcing obstacles include:

Explosive Road Cuts. Craters can be effective for creating large roadway cuts for roads that are flanked by steep slopes on both sides, especially when the roadway is the highest surface and the sides slope away from the roadway. If the roadway is cut into a hillside, then a cratering demolition charge may be effective in creating a **landslide** (figure 44) or **mudslide**. The landslide can be initiated above (to cover over the roadway)

or below (to undermine the roadway), depending on the stability of the soil on the slope. An **avalanche** may also be used to cover a roadway with snow and debris.

Abatis. An abatis is a tree-strewn roadway or trail where large trees are felled from both sides of roadway in a crisscross pattern. The trees are felled such that the tops of the trees are facing the direction of advance by the opposing force (figure 45). It is used most effectively where the roadway cuts through a dense forest and the area can be reinforced with mines, booby traps, and entanglements. The trees may be cut with power saws or explosives; the abatis is more effective when the base of the trunks are left partially attached to the stumps.

Figure 44. Cratering Charge formed Landslide.

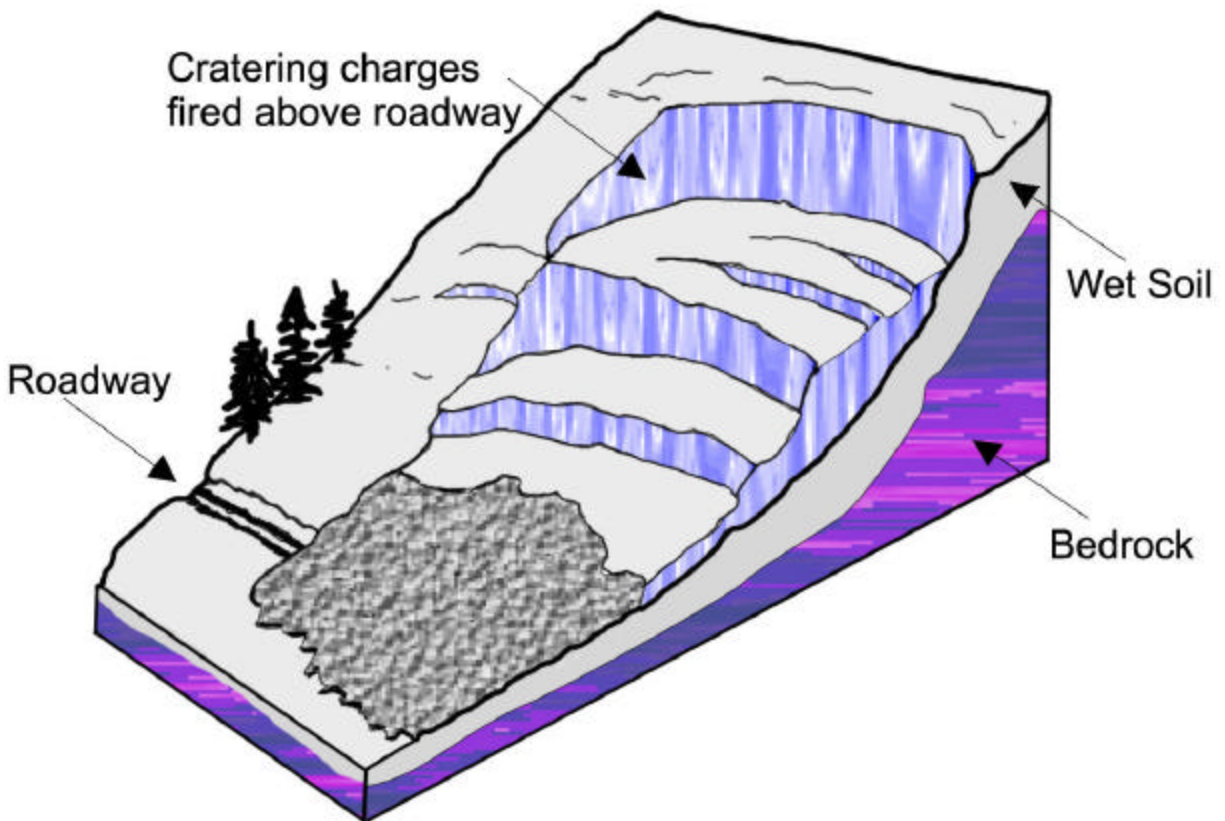
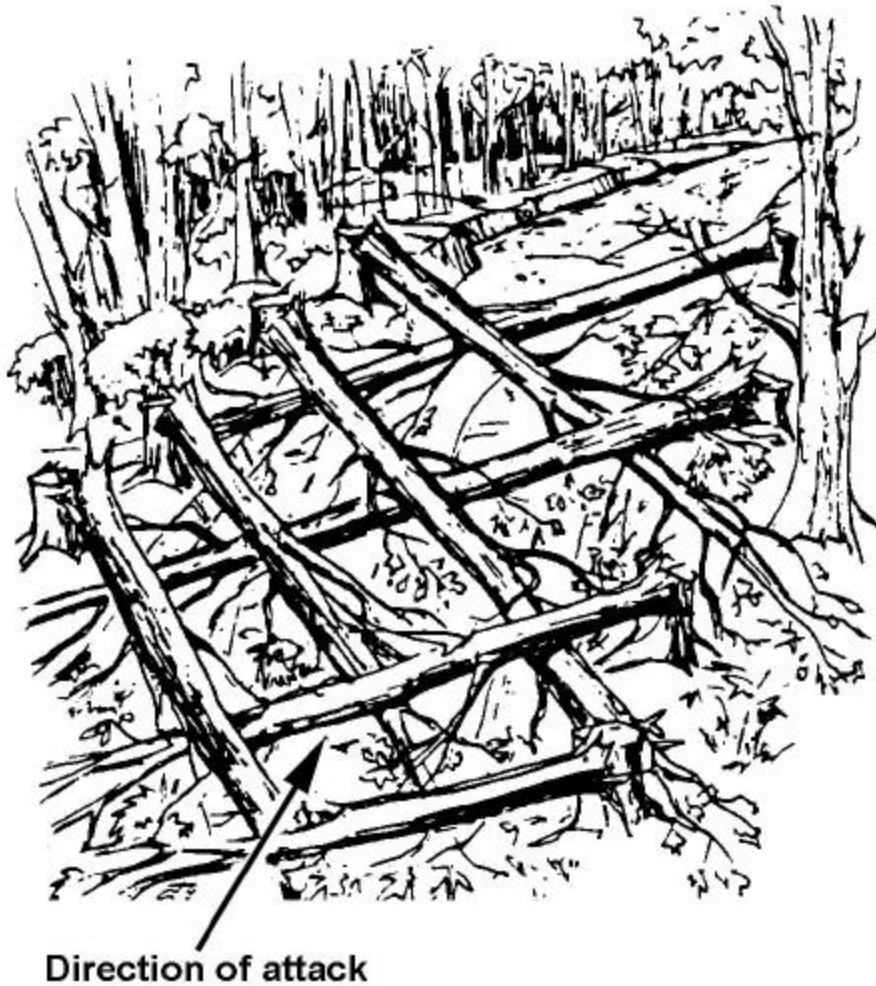


Figure 45. Abatis on Forest Road.

Ditches. There are basically two designs for ditches, rectangular and triangular (figure 46). Ditches may be cut across a roadway or a sloping hillside. They are very effective for slowing or stopping vehicles. Ditches designed to stop tracked vehicles should be **at least 1.5 meters deep and 5 meters wide**. Shallower and narrower ditches may be effective against many types of wheeled vehicles. Constructing ditches can be equipment intensive. They may have to be revetted to prevent being easily filled in or collapsed. The placement of additional obstacles such as log hurdles or spoil mounds (figures 47 and 48) makes ditches more effective for slowing vehicles. When placed at blind curves or hilltop transitions, they can cause speeding vehicles to go out of control into a ditch.

Figure 46. Typical Ditch Construction.

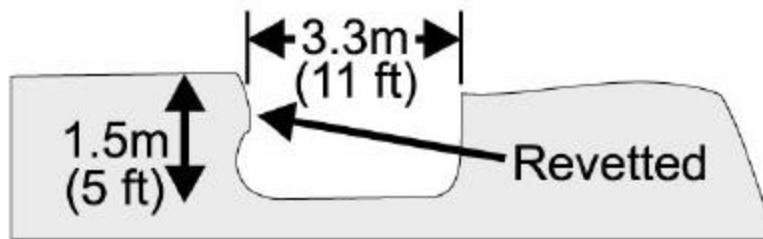
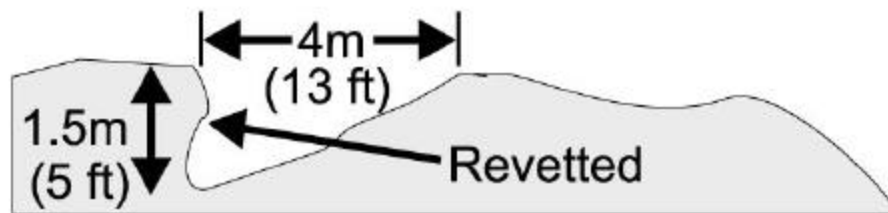
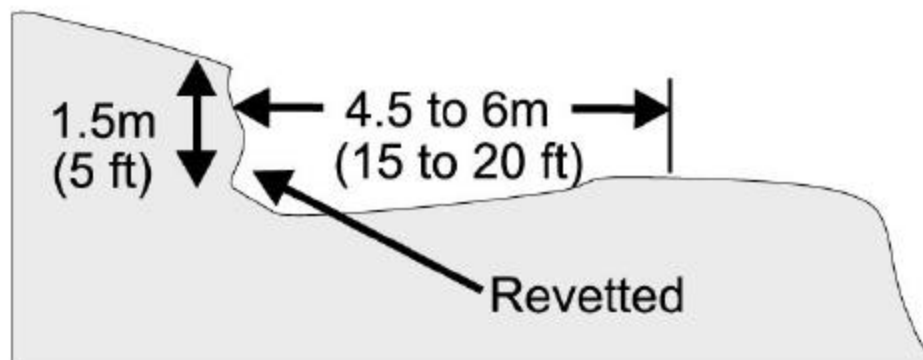
**RECTANGULAR DITCH****TRIANGULAR DITCH****SIDEHILL CUT DITCH**

Figure 47. Locating Log Hurdles.

EMPLOYMENT OF LOG HURDLES FOR A RECTANGULAR DITCH

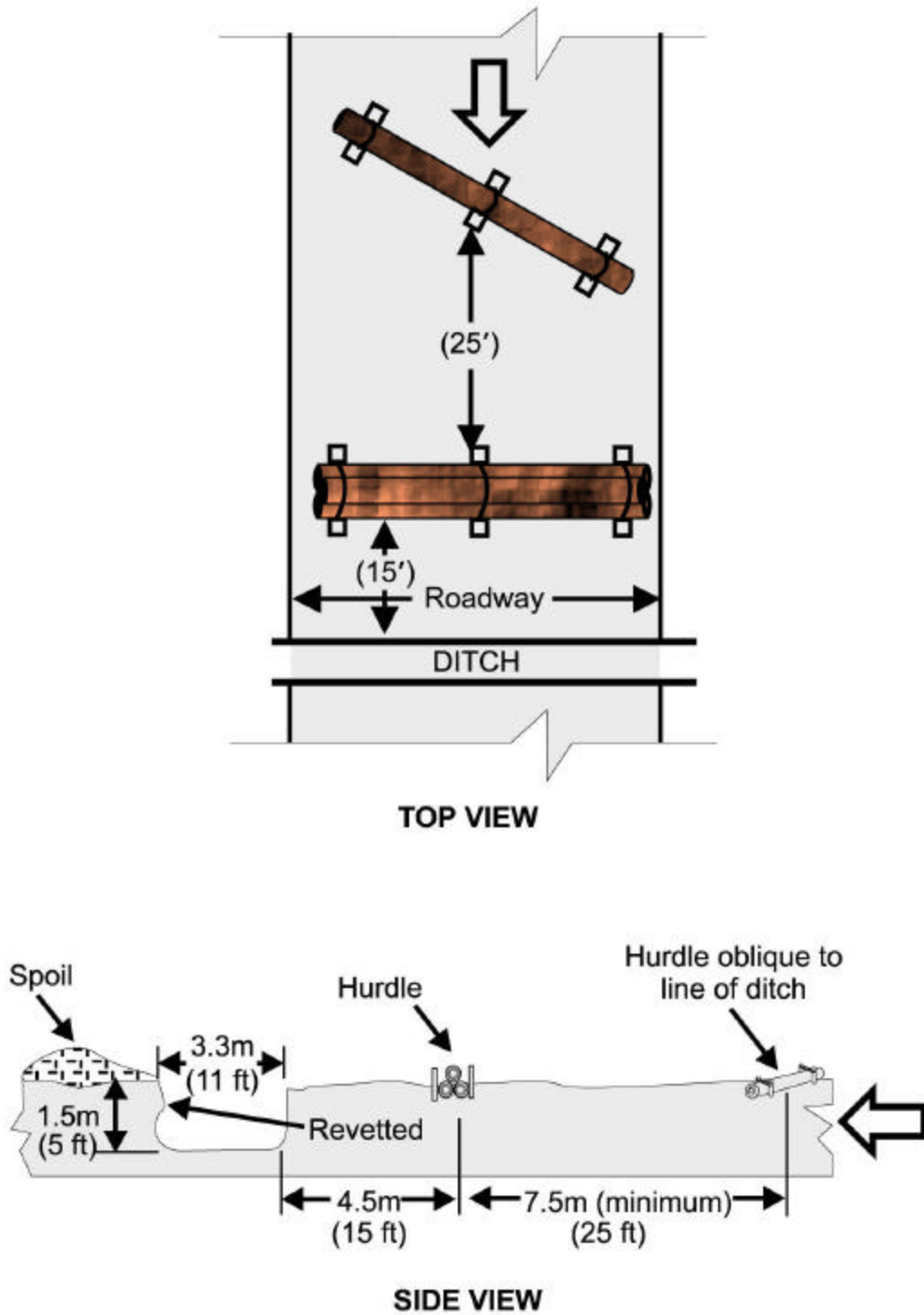
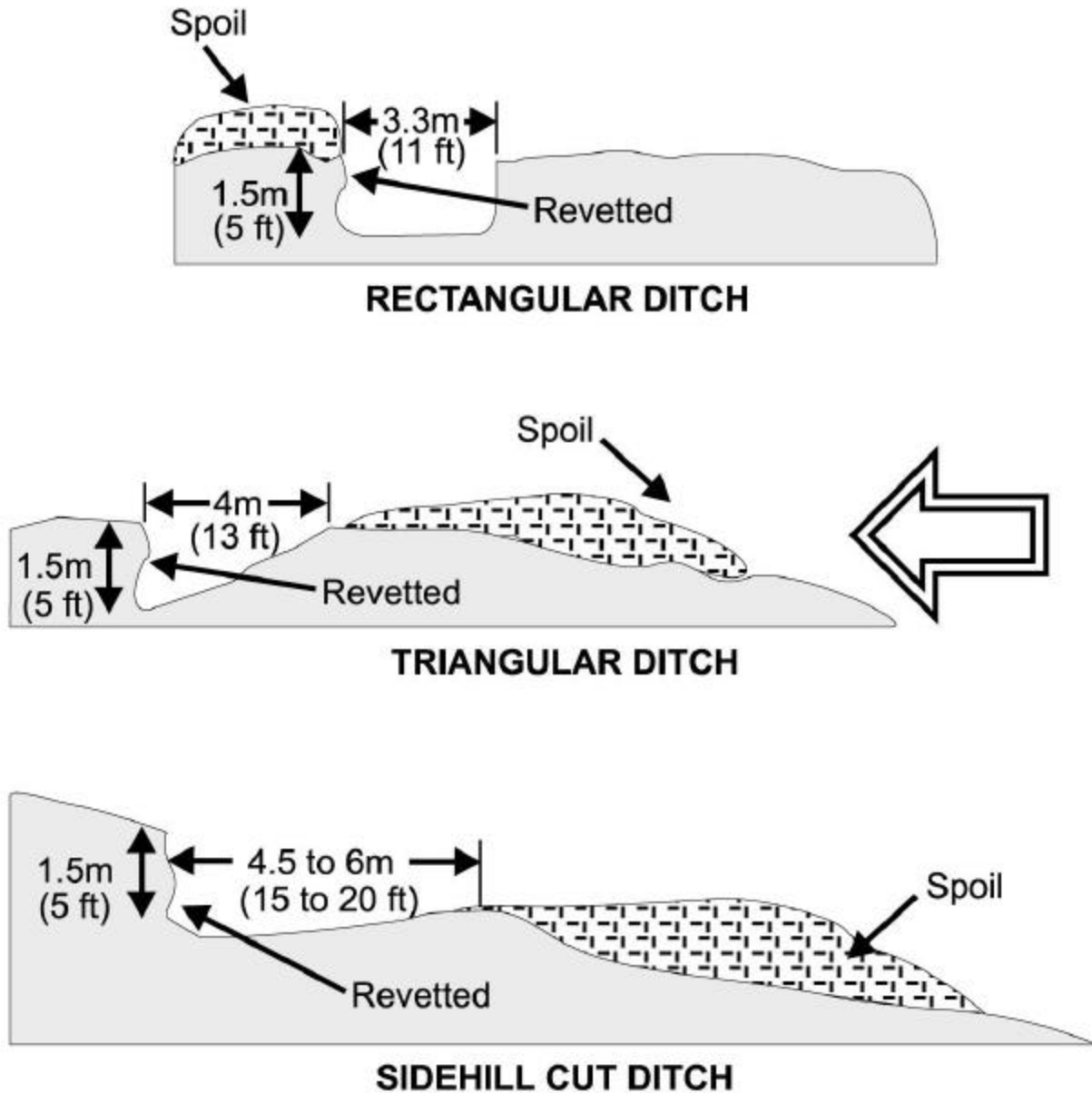


Figure 48. Locating Spoil Mounds.



Hurdles. Hurdles are logs, poles, or pipes that can be placed separately or lashed together to form approximately 18-inch high barriers across the path of a vehicle. Individual logs may be as small as 10 inches in diameter if they are lashed or wired together and staked in place (figure 49). Stagger several short (about 6 to 7 foot long) widths of hurdles together or two longer logs (that are the width of the pathway) across the path of travel. Stagger the shorter segments about 10 to 12 feet apart and place the full width logs as shown in figure 50. Hurdles can either slow a vehicle to allow security forces to open fire as in an ambush or cause a vehicle to go out of control and be stopped when used with other obstacles, such as ditches or log cribs.

Figure 49. Log Hurdles.

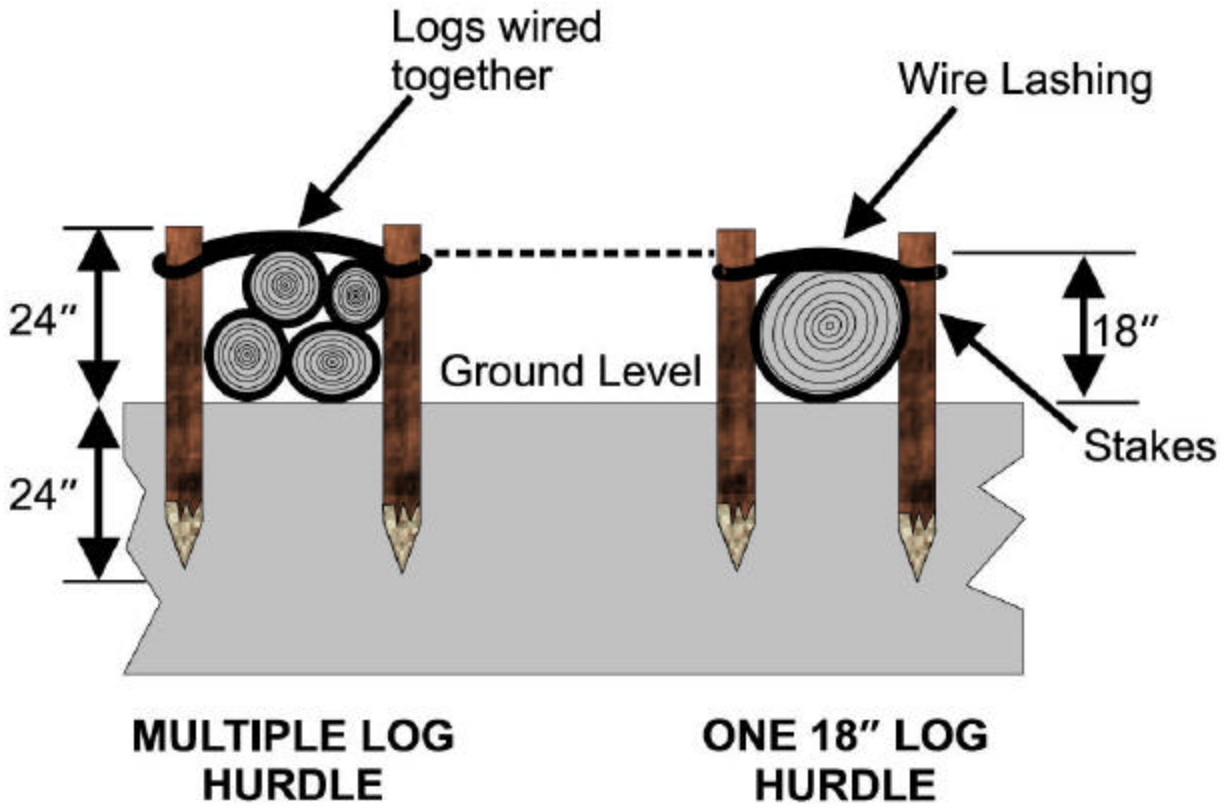
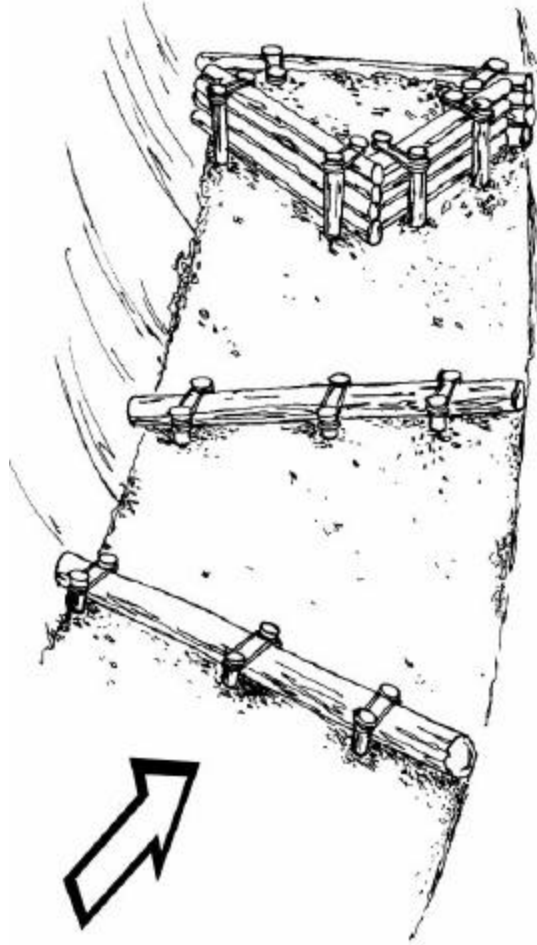
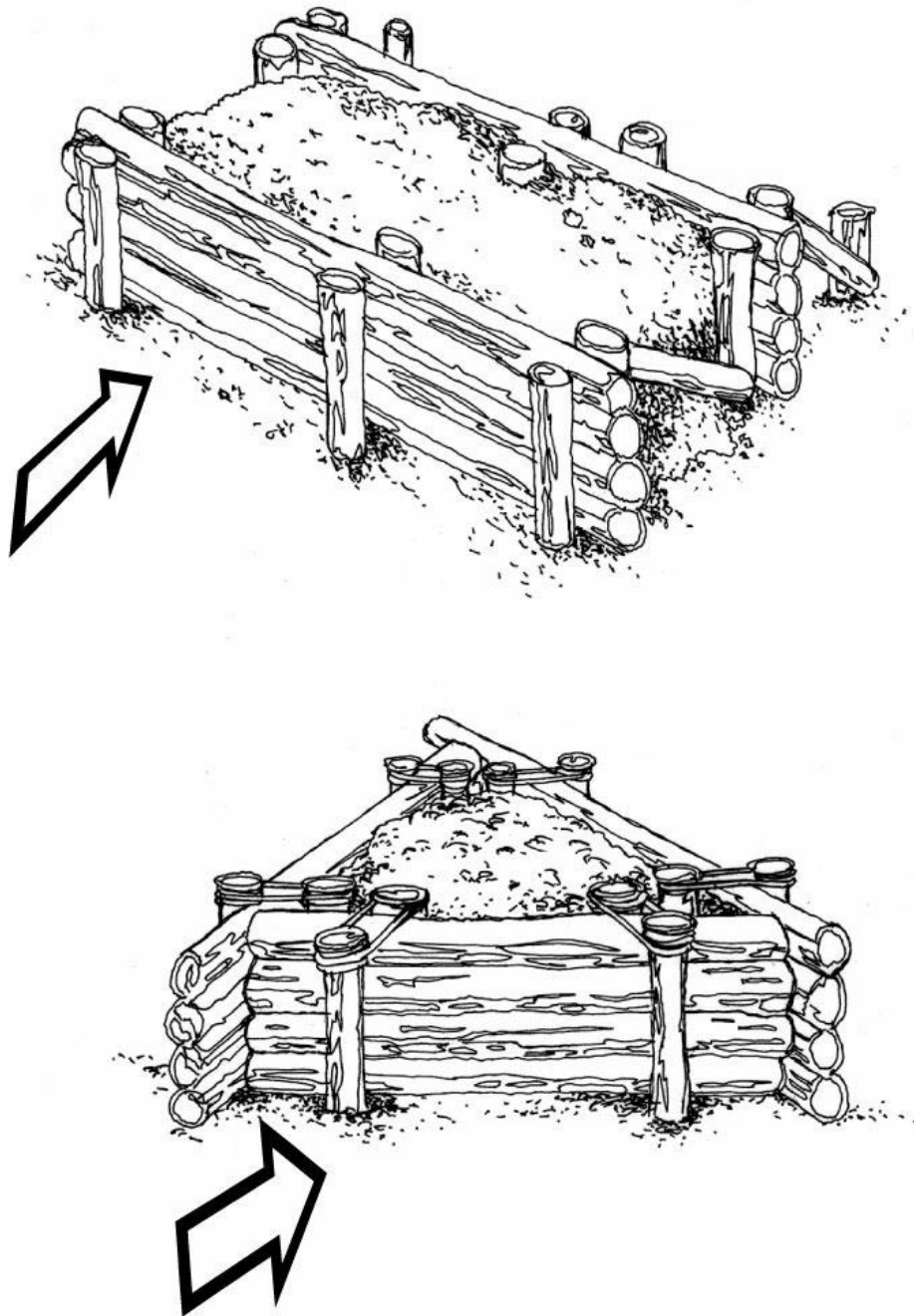


Figure 50. Staggering Placement of Hurdles.



Cribs. Cribs are short sections of logs, steel planks, or other materials fashioned together as bins to contain dirt or rocks. Log cribs can be rectangular or triangular and are used to block vehicle paths of travel on narrow roads (figure 51). When possible, fill the cribs with material from a ditch cut in front of the crib. Anchor revetment materials to prevent them from being easily pushed out of the way.

Figure 51. Log Cribs.

Expedient Posts. Wood logs or steel piles can be used to stop most vehicles; partially bury or drive them into the soil at an angle between vertical and 50° toward the direction of movement (figure 52). The posts should be braced with another pole buried and run behind the line of posts. The posts should be approximately 10 feet long with 3.5 to 4 feet above ground. Set the posts between 3 to 4 feet apart in rows, with 10 feet between rows. The logs can be aligned or somewhat staggered between rows. Logs should be a minimum of 5 inches

in diameter for a hardwood, but a larger diameter log (i.e., about 10 inches in diameter) should be used for softwoods. Posts are very effective against vehicle movement and when coupled with wire entanglements (figure 53) and/or mines, are effective in slowing or blocking personnel. If the posts are not high enough to be pushed out of the way, they can throw the tracks from tracked vehicles.

Figure 52. Expedient Log Posts.

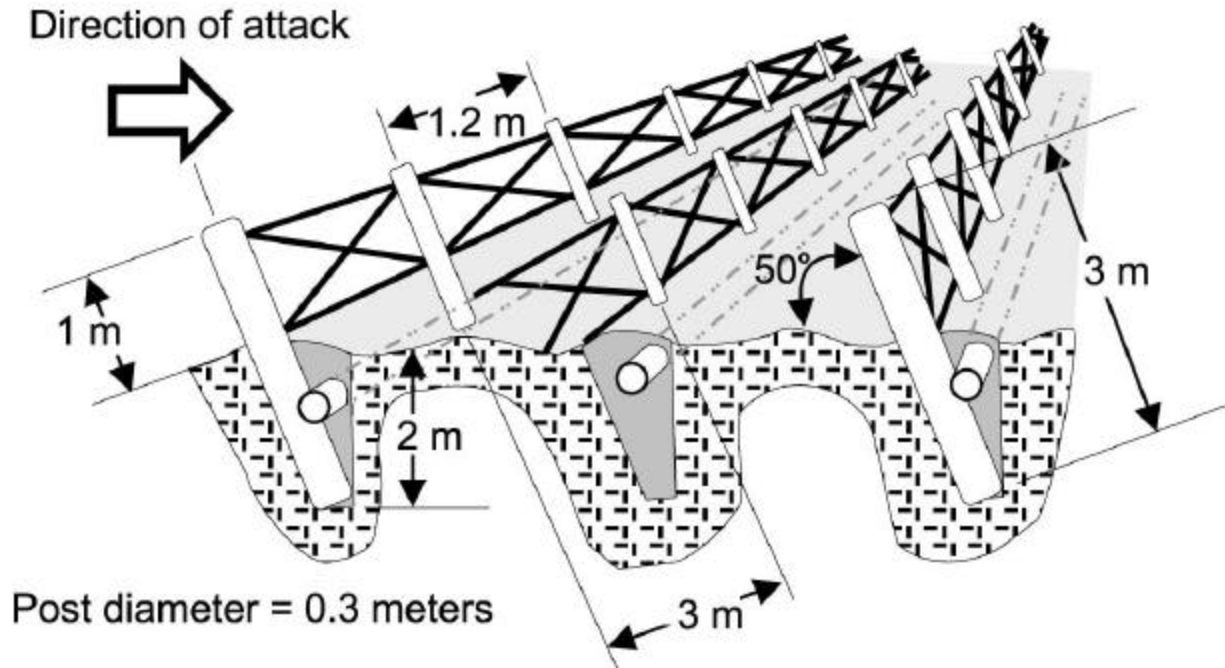


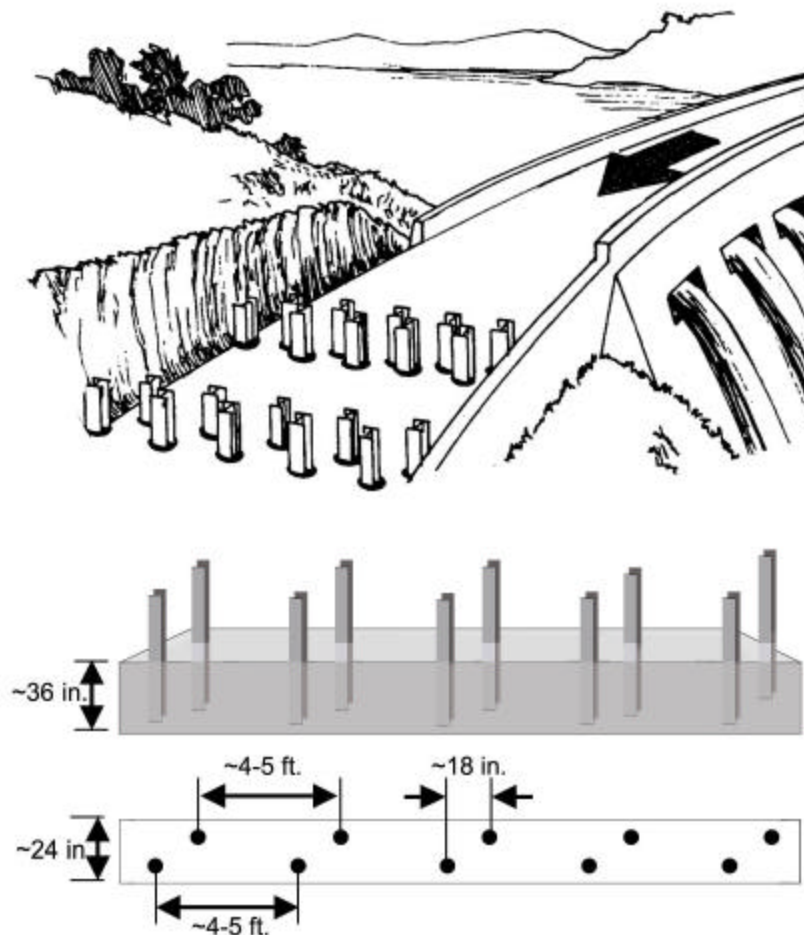
Figure 53. Posts and Entanglements along Roadway.



Prefabricated Posts. When a roadway is usually kept open, but may have to be quickly closed, removable posts can be set in a prefabricated concrete base. Use steel posts such as heavy-walled, 6-inch diameter pipe or 6 x 6 WF or Ibeam structural steel; the posts should be approximately 7 feet long. Pour a concrete base approximately 36 inches high (deep) by 24 inches wide under the road surface for the width of the road surface. Place a 30-inch long steel pipe sleeve in the concrete, slightly recessed from the top of the concrete; the inside diameter of the sleeve should be just large enough for the post to slide inside. The number of posts, their spacing, and the number of rows of posts should be determined by availability of time, materials, threat, and location. To stop heavier vehicles, the pipe type posts can be filled with concrete. Stagger the sleeves as shown in figure 54; keep posts about 4 to 5 feet apart, staggered by about 18 inches front and back for each row. Keep rows about 10 feet apart.

Place a cover over the top of the sleeve when not in use. If for long term use, use steel reinforcing in the concrete. When required, remove the cover and drop the posts into place. The posts will require several personnel or a front-end loader to lift. Lift handles may be welded to the exposed end of the post. Run concertina wire throughout the rows, especially near the lift handles. To prevent rapid removal by advancing forces, weld the posts to the sleeve. If used for protection against [terrorist] intrusion, then concertina wire may be adequate to prevent post removal when the location is under observation.

Figure 54. Placement of Staggered Posts.



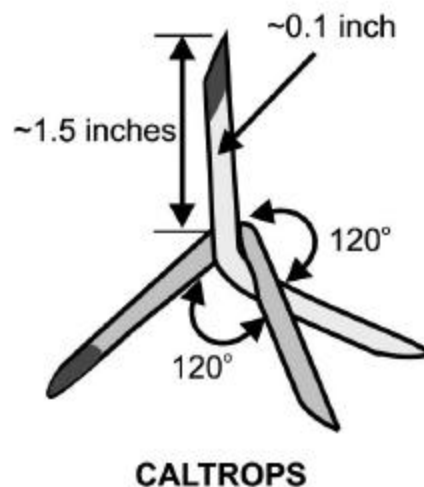
Steel hedgehogs. Hedgehogs are six-pronged obstacles formed from three-pieces of 4-foot long 4 x 4 angle iron (figure 55). They weigh about 160 pounds and are designed to rotate under vehicles and either immobilize or overturn them. Hedgehogs can be welded together with angle iron, with or without additional backing plates, where the three pieces are joined. Unless used and concealed in vegetation, they can be readily spotted and removed by advancing forces. When hidden in brush or other vegetation, they can stop vehicles moving cross-country through tall grass and brush or into less dense openings of forests with new saplings and brush. They can be kept separate or have several cabled together to cause several hedgehogs to be drawn under and into vehicles. Smaller sizes of hedgehogs using smaller angle iron and shorter, sharpened ends can be made and chained together for rapid deployment by tossing or towing across roadways or pathways traveled by cars and smaller commercial vehicles. This is a rapid means item for protection against [terrorist] intrusion.

Figure 55. Steel Hedgehogs.



Caltrops. Caltrops are small, four-pronged obstacles (figure 56) used to penetrate vehicle tires or footgear. They can be very effective against personnel and vehicles without foam filled tires. Each caltrop leg is about 1.5 inches long and about 0.10 inches in diameter. Caltrops can be made from 16- or 20-penny nails with their heads cut off, both ends sharpened, bent at a 120° angle in the center, and spot weld at the center. They are typical used in place of triple concertina wire and are not easily detected or removed. They are spread at a density of 30 to 40 per meter of front.

Figure 56. Metal Caltrops.



Concrete blocking obstacles. Concrete cubes and cylinders can be easily constructed. The 4-foot cubes of concrete can be cast in place, while the 4-foot diameter (3.3-foot high) cylinders of concrete (figure 57) can be cast in place or precast and moved into position. Place the obstacles in irregular patterns to prevent wheeled and tracked vehicles from moving between them or pushing the obstacles out of position. They can be used between buildings or on top of elevated roadways to block traffic.

Tetrahedrons and dragons teeth. Steel and concrete tetrahedrons are pyramids with a triangular base, while dragons teeth are concrete pyramids with a square base (figure 58). The large concrete tetrahedron must be moved with heavy equipment and is effective in areas with limited access, such as on roadways between buildings, either to stop vehicles or delay tanks. Dragons teeth are employed in depth in multiple rows across an avenue of approach to stop or delay vehicles. Space the dragons teeth about 4 to 5 feet between teeth and rows across the avenue of approach; rows can be aligned or staggered.

Figure 57. Concrete Cube and Cylinder.

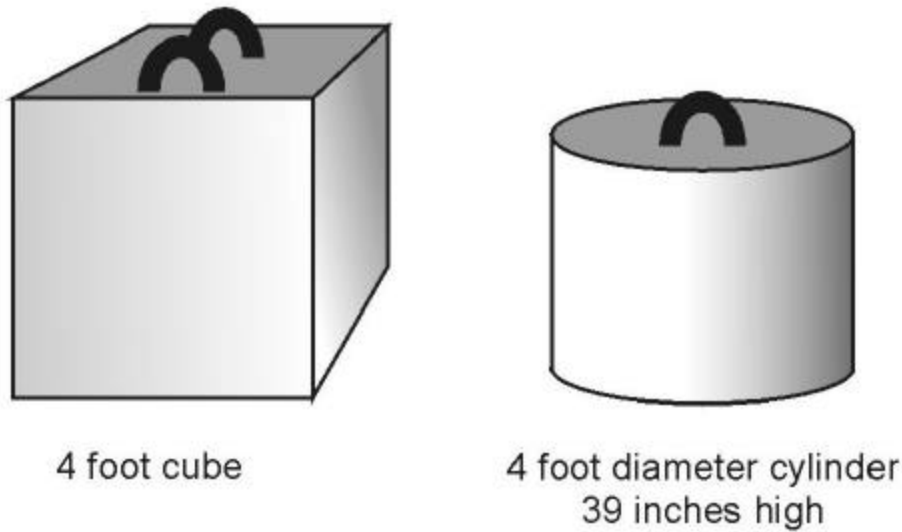
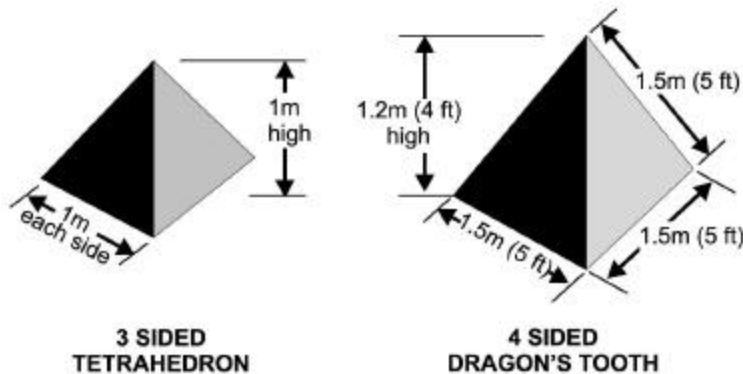


Figure 58. Concrete Tetrahedron and Dragons Tooth.



Rubble, Junked Vehicles, and Damaged Equipment. In built-up areas, rubble from buildings, vehicles, or damaged equipment can be moved into location separately or used together to block roadways or limit movement of personnel and vehicles. By moving equipment and rubble together near damaged facilities (figure 59), large areas can be restricted and provide hasty fighting positions for security forces.

Figure 59. Rubble Blocking Urban Streets.



Wire Entanglements. Wire entanglement obstacles are targeted towards stopping personnel and some vehicles, and preventing personnel from removing other obstacles that are stopping vehicles. They normally consist of barbed wire, concertina wire, and triple concertina wire with pickets. They can be employed at numerous levels above the ground. A Tanglefoot layout uses barbed wire run low (between 9 and 30 inches above the ground) in tall grass, scrub, and brush. It should be anchored on small pickets as well as draped through shrubs and on twigs, to cause tripping and injury to the legs of advancing personnel (figure 60). Lay the barbed wire in patchwork patterns of boxes and corridors with a minimum width of 32 feet and at irregular intervals of 2-1/2 to 10 feet between strands. Barbed wire can also be hidden and interwoven in hedgerows or bushes at various levels. Figure 60 provides an example of an avenue of approach to a base along a stream valley. The overhead drawing maps out the suggested positioning of tanglefoot layouts and fighting positions for base security forces. Tanglefoot layouts are used to slow (i.e., fix) and disrupt the movement of enemy groups and to help create an engagement area of advantage to base security forces.

When laid in depth (about 11 rows deep) across a roadway, strung concertina wire can be used as a roadblock (figure 61). It is effective when supported by pickets and used with steel hedgehogs. However, the most common use of concertina wire is in a standard triple concertina fence which is strung across avenues of approach, between separated obstacles, or parallel to ditches and stream or river banks. Triple concertina fences (figure 62) are effective, especially around assets and facilities that are monitored or observed. They can slow or halt (terrorist) intrusion and allow security forces to move in and coordinate weapons fire.

Figure 60. Tanglefoot Layout -- Example.

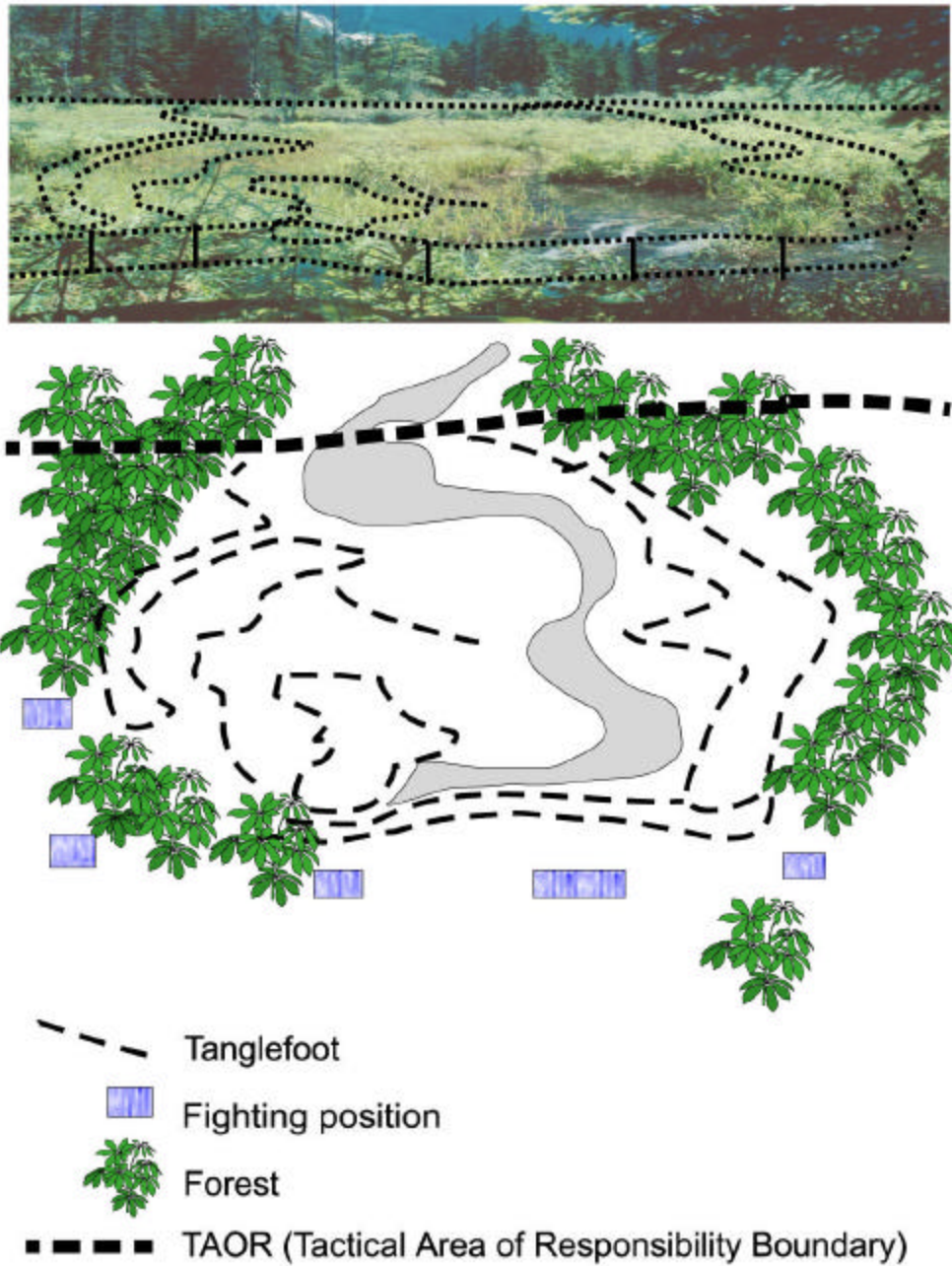
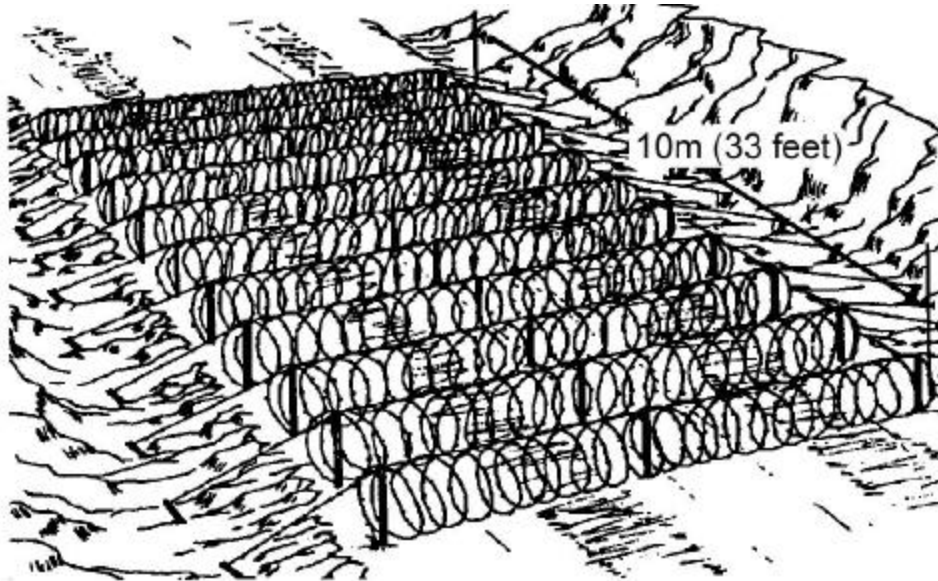


Figure 61. Concertina Wire Roadblock.



Heavy equipment and vehicles. Most Civil Engineers would prefer not to have to use equipment assets as obstacles or movable gateways. However, when an obstacle **must be quickly moved into/out of position to allow security forces rapid access to an area**, such as at a critical flightline entry point, large earthmoving equipment and loaded dump trucks work well as a temporary measure.

Obstacles used against Terrorists. Many of the obstacles listed above may be used to disrupt or stop terrorists from entering an installation or deployed location. Additional expedient obstacles may be used; some of the obstacles may require prefabrication and storage until required. Other obstacles can be installed expediently, but may require support using a construction project. Most of the obstacles are best employed at entrances to the base or near specific areas of high value. The ability of the obstacles to stop vehicles is depicted in figure 63, which provides stopping capabilities for some obstacles against vehicles of a given weight.

Figure 62. Triple Concertina Fence.

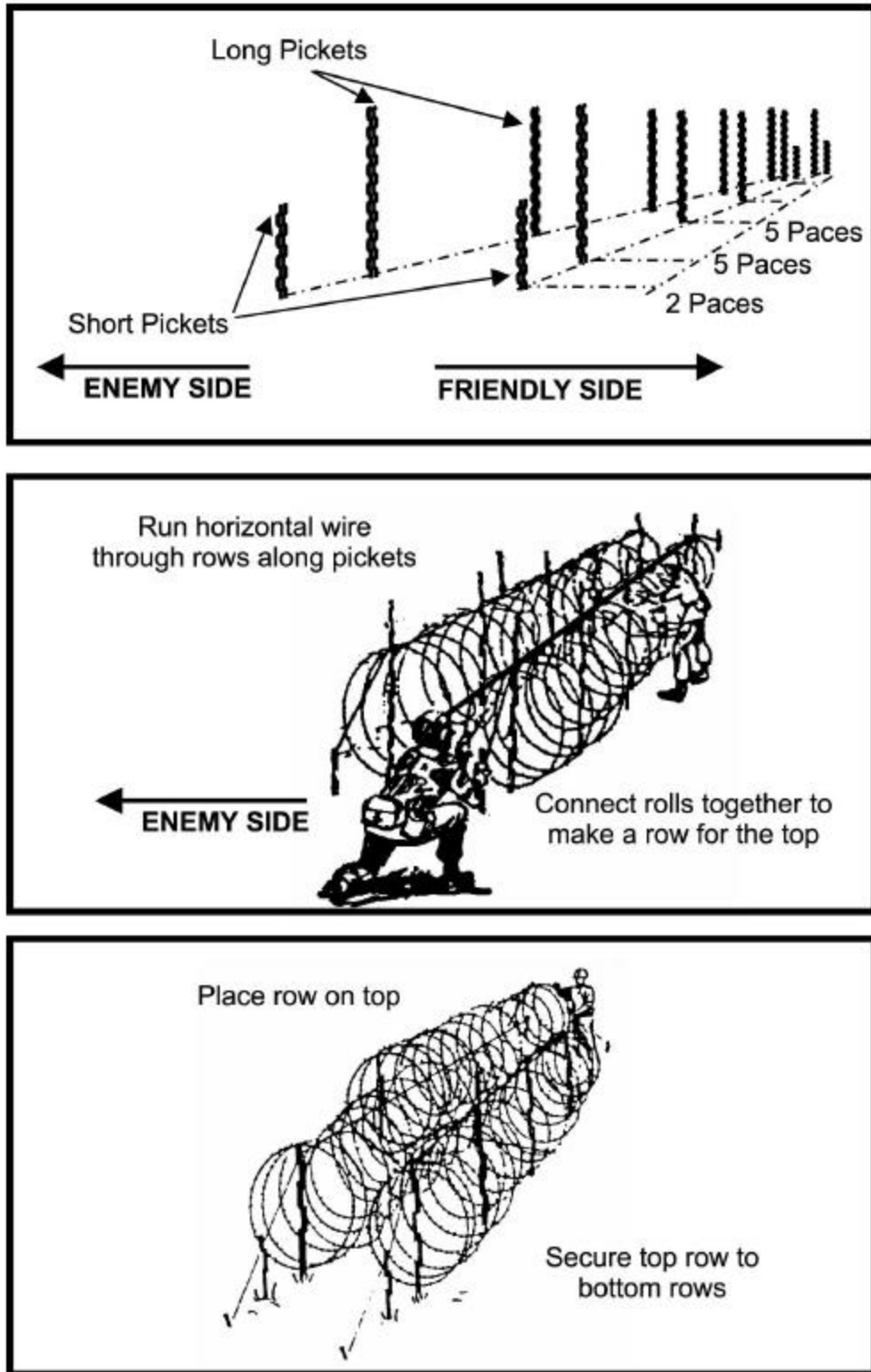
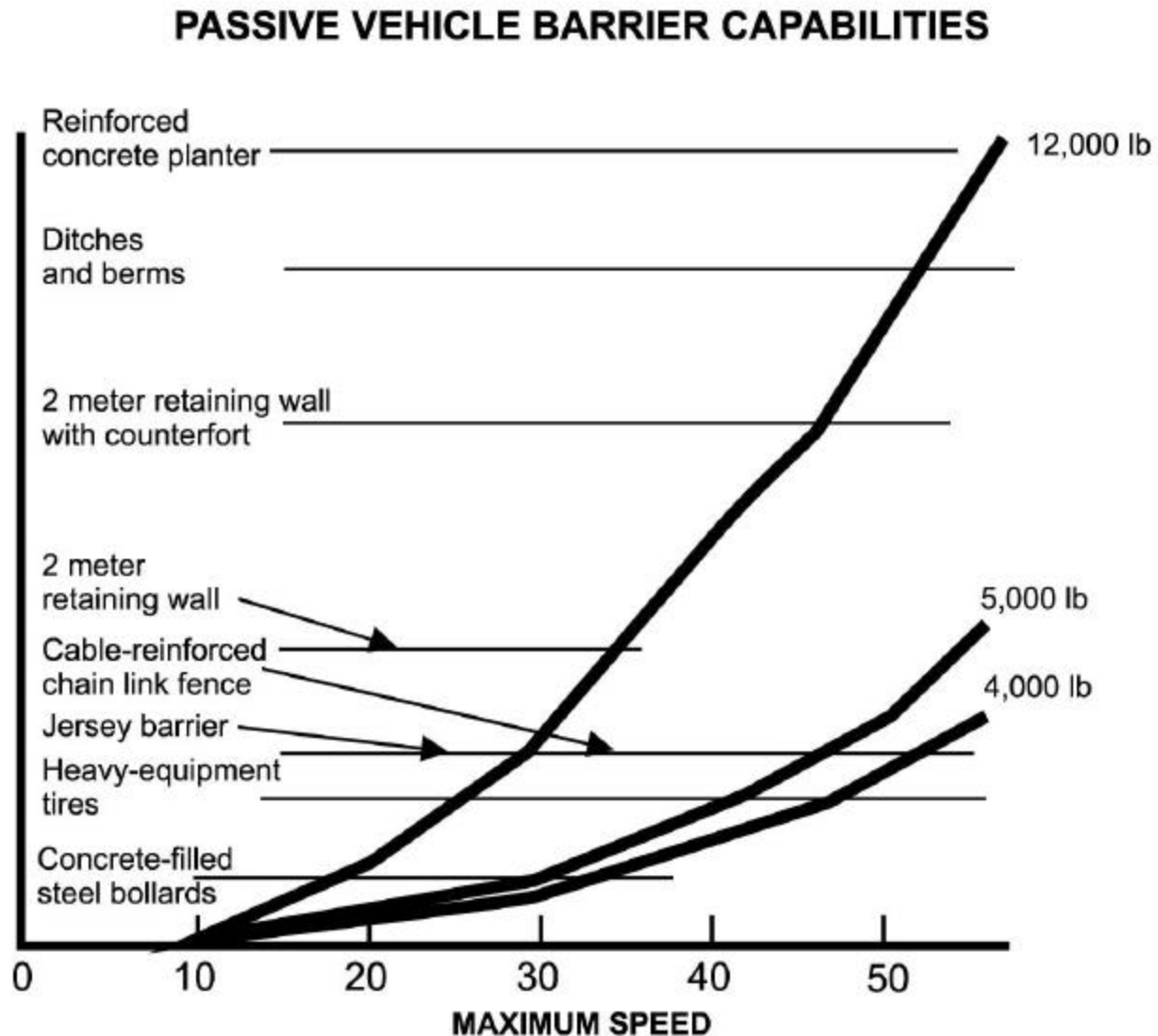
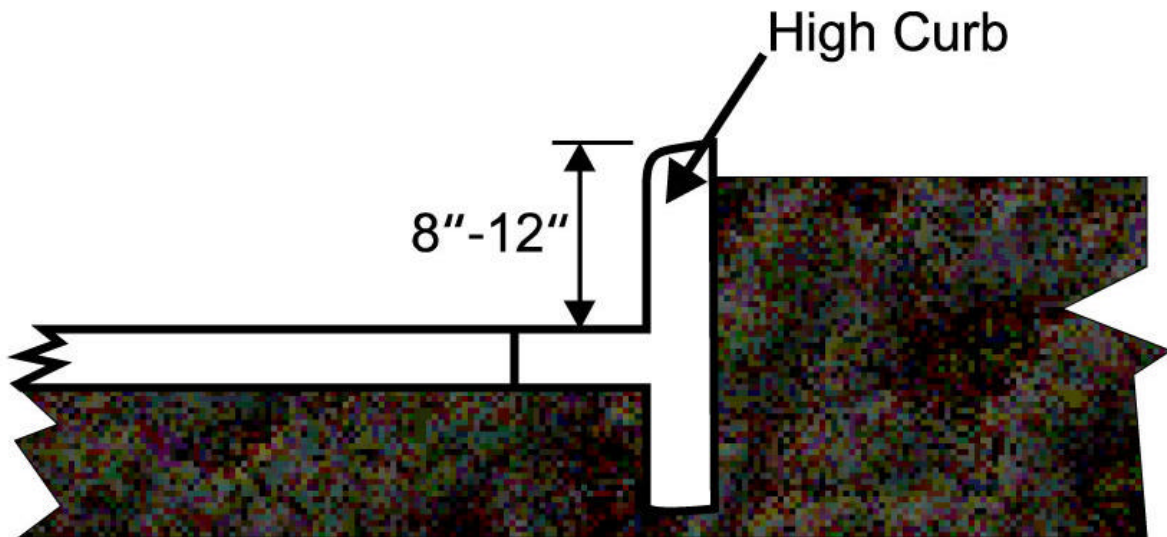


Figure 63. Stopping Capabilities of Obstacles.

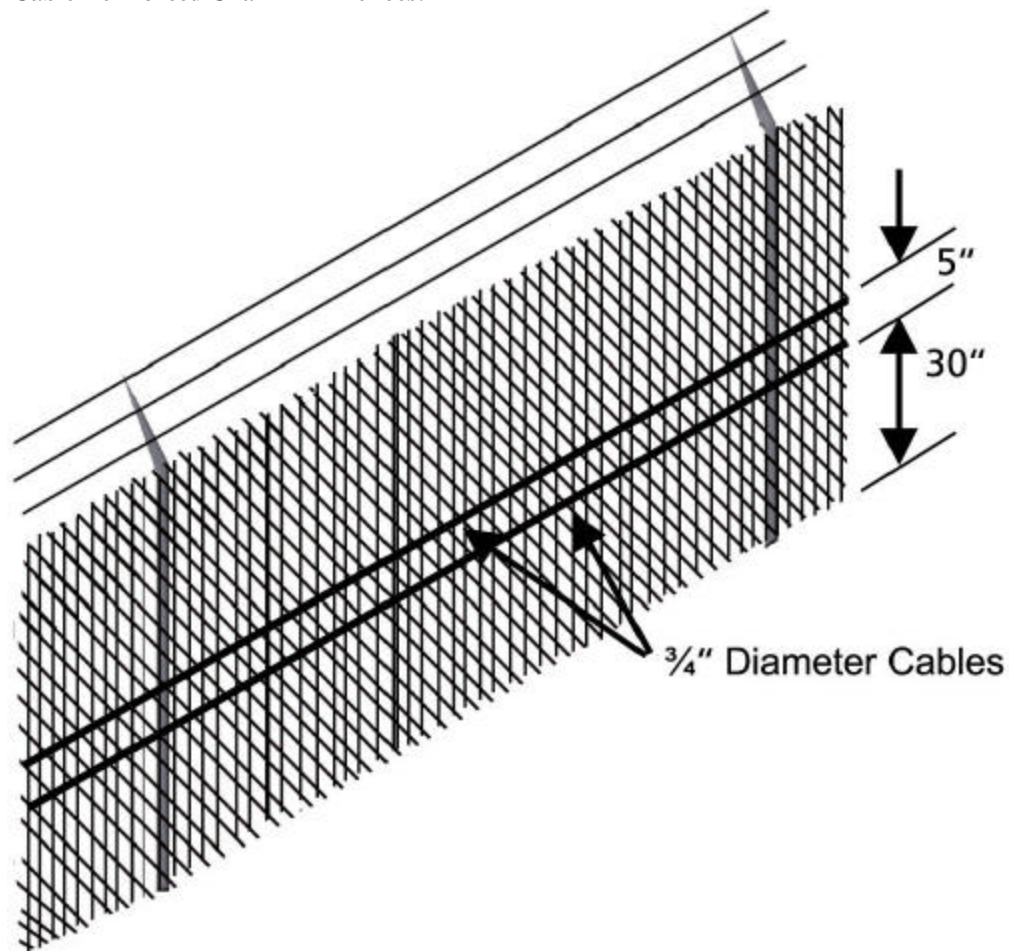


Straight curbs: High (8- to 12-inch), straight-faced curbs (figure 64) can be used along roadway entrances and around critical facilities to restrict travel of conventional vehicles to established roadways and entrances. The high curbs can damage tires, the undercarriage, and steering of vehicles attempting to gain high-speed access into areas. The height and shape of the curves may also prevent some automobiles from leaving the roadway along a secure route.

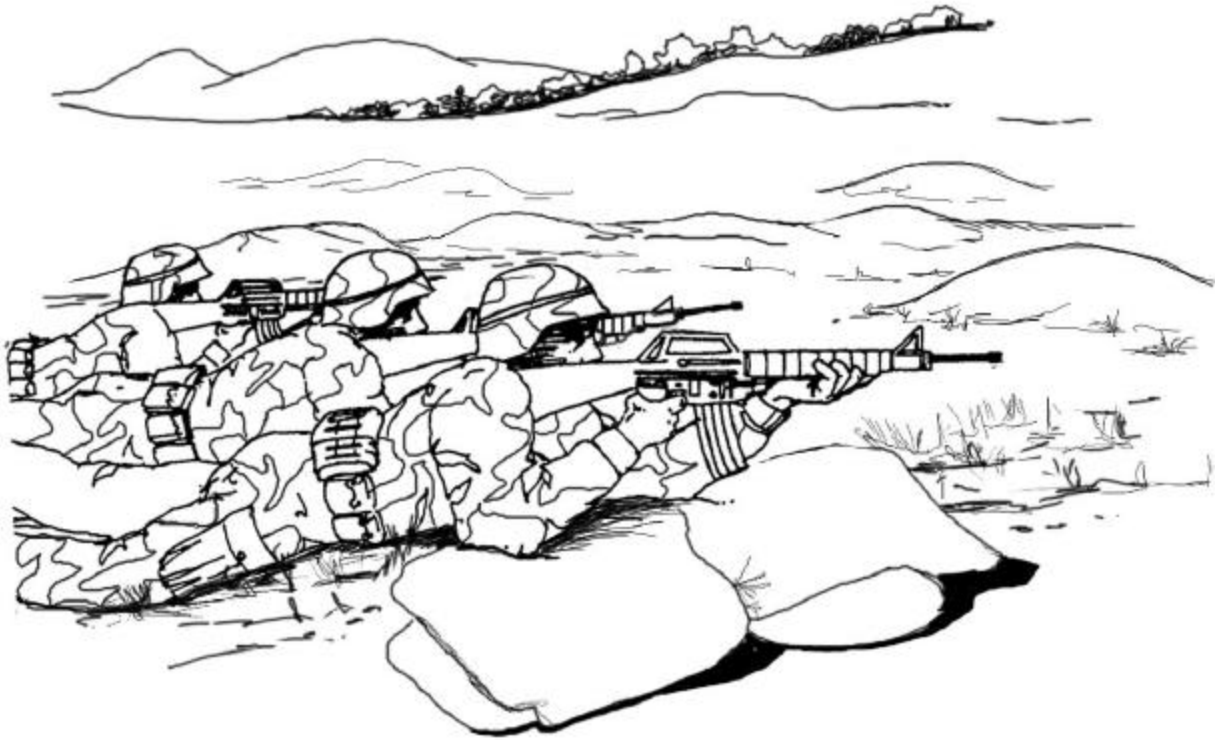
Figure 64. Straight Faced Curb.

Fencing and decorative entries. High strength ornamental fences (such as heavy wrought iron), chain link fences, cable reinforced chain link fences (figure 65), and decorative posts and chains are all ways to slow or stop terrorists on foot and/or in vehicles. Decorative posts should be at least 4 inches in diameter and spaced 4 foot-on-center. Heavy chains or cables strung between the posts add to protection from vehicles. Cable reinforced chain link fence should have two 3/4-inch diameter cables strung at 30 inches and 35 inches above the ground.

Trees and shrubs. Dense shrubs and established trees larger than about 6 to 8 inches in diameter can be used to restrict vehicles, but could provide cover for personnel trying to approach a facility. The use of posts within the vegetation and chain link fences topped with barbed wire behind the vegetation can provide some additional protection against vehicles driving between trees and personnel trying to slip past security through the vegetation. The use of trees and shrubs can be maintenance intensive in some regions and must be adequately maintained to prevent unauthorized access.

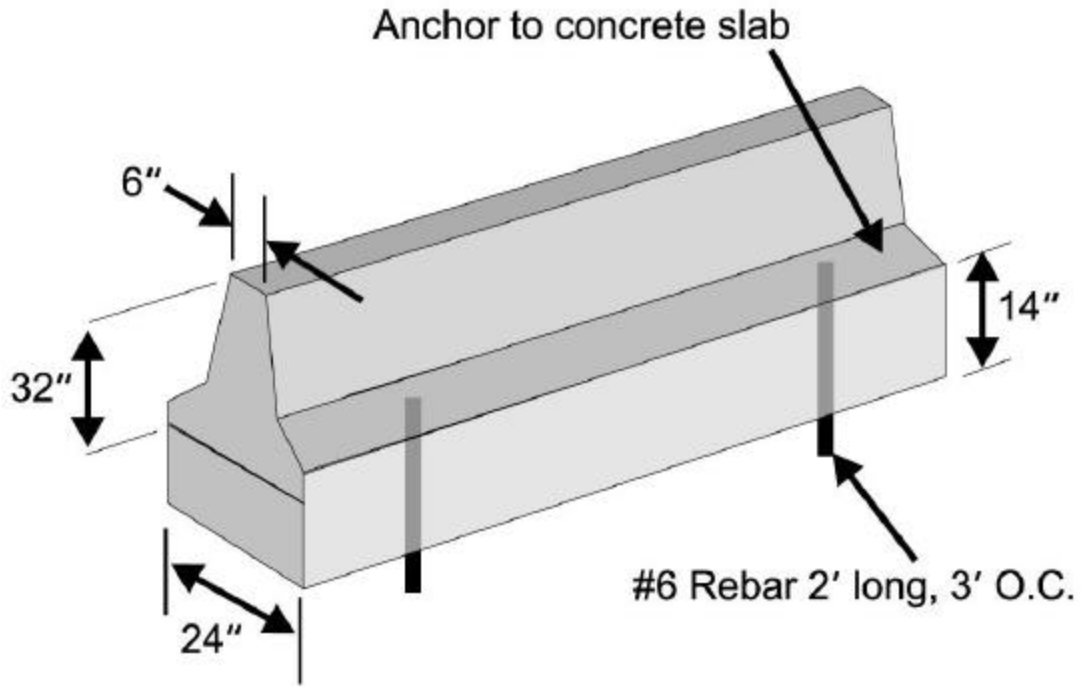
Figure 65. Cable Reinforced Chain Link Fences.

Shallow ditches and berms. Along with trees and shrubs, ponds, shallow ditches, and berms can be included in construction projects as a part of landscaping for facilities. If not already incorporated into the landscape, Civil Engineers can provide expedient protection by cutting and filling to form shallow V-shaped ditches and berms or moguls in front of and behind a ditch (figure 66). Shallow ditches and berms and moguls can prevent vehicles from cutting cross-country. By using more gradual shapes and slopes, the terrain features are harder to avoid by fast moving vehicle. The gradual slopes also provide less opportunity for intruders to hide behind cover or in shadows when trying to infiltrate an area.

Figure 66. Shallow Ditches and Low Berms and Moguls.

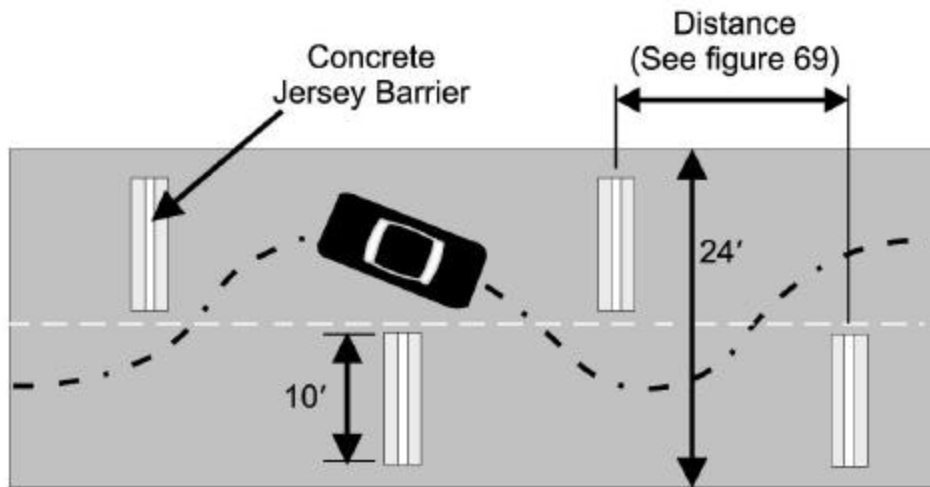
Vertical barriers: There are numerous vertical barriers that can be employed as temporary, fixed, or movable obstacles. Sandbag revetments, half-buried heavy-equipment tires, and filled (wire roped together) 55-gallon drums are very expedient obstacles that can be constructed to prevent vehicle access. Concrete retaining walls and large concrete planters can be installed semi-buried to stop vehicles. Retaining walls, large concrete planters, and Jersey barriers (figure 67) can be used on top of pavement to either stop vehicles, or when spaced out between lanes, can force vehicles to slow down and negotiate a slalom of obstructions (figure 68). As shown in figure 69, the graph indicates that with proper spacing, speeding cars can be sufficiently slowed to provide time for security forces to take action. Removable heavy steel pipes (called bollards when filled with concrete) can also be used in pavement systems to create slalom courses for speed reduction.

Figure 67. Jersey Barrier.

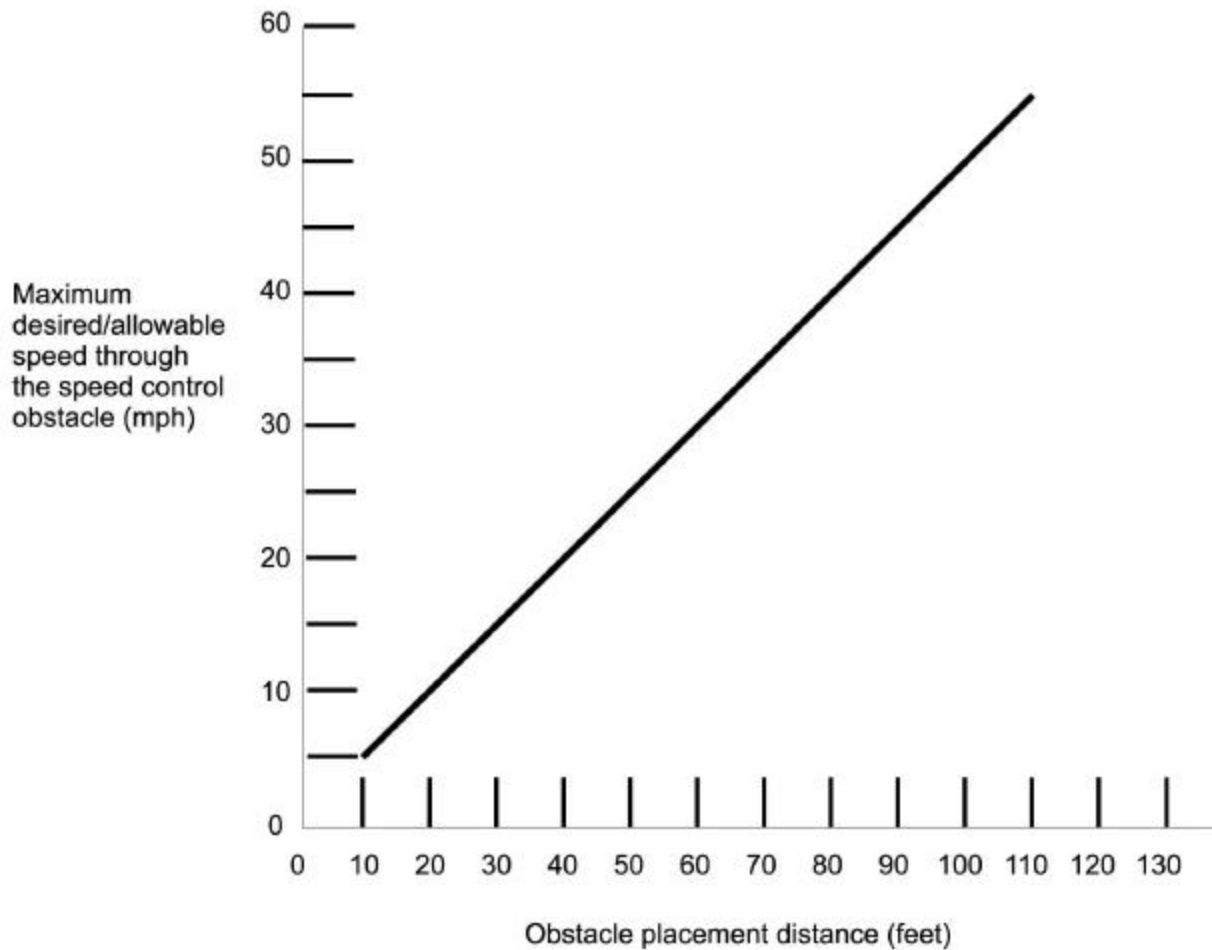


JERSEY BARRIER

Figure 68. Placement of Roadway Obstructions.



CONCRETE OBSTACLE PLACEMENT

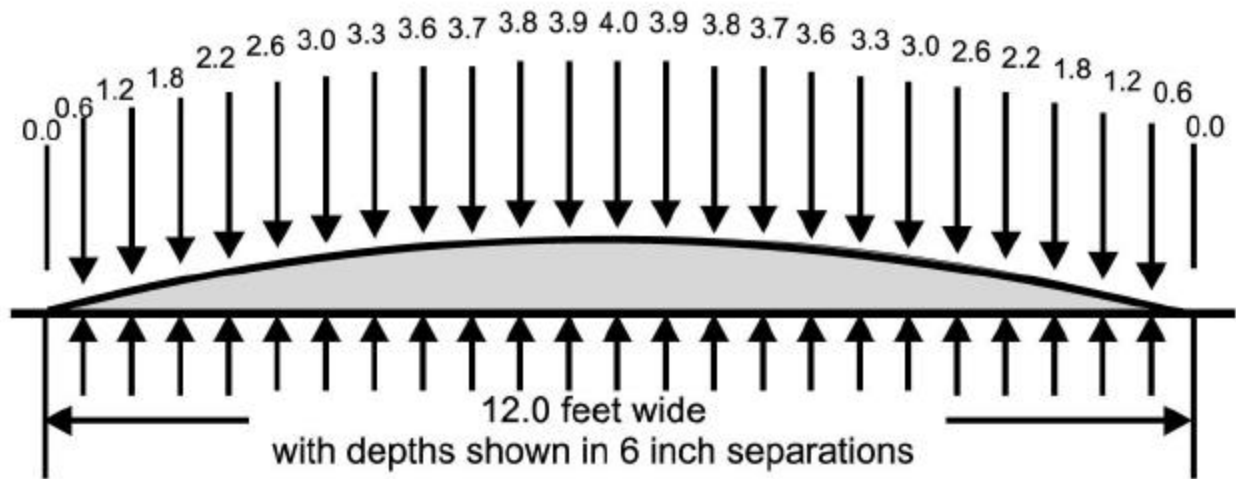
Figure 69. Barrier Spacing versus Automobile Speeds.

Various other speed-control obstacles. Barriers can also be used to channelize traffic into long, narrow corridors or tight turns. When an area is first being evaluated during deployment, consider the use of traffic circles with barriers and vertical curbs as part of the security measures for slowing and controlling vehicles. A series of speed bumps is often effective for controlling many smaller vehicles. The use of paved speed humps is an effective measure to stop many trucks.

Speed bumps are normally 3 to 4 inches high and 1 to 3 feet long. They can be constructed with asphalt paving or by using anchored landing mats. Placed in a series, they may make vehicles slow, but normally will let larger vehicles and vehicles with high or loose suspension pass over them at higher speeds.

Speed humps are also about 3 to 4 inches high, but are about 12 feet long and are shaped like a parabola (figure 70). When spaced at 275-foot center-to-center intervals, they allow 25-mph speeds to be maintained. However, by placing the humps closer together at less than 100-foot center-to-center spacing or at angles to the roadway, speeding vehicles may lose control and cargo in trucks can be tossed about. Closely placed speed humps may pose a safety problem for use with normal truck traffic and can cause control and comfort problems for some drivers of cars and light trucks. Therefore, bases should avoid using closely spaced speed humps as a long-term measure for speed control and for control of high volume roadways.

Figure 70. Typical 4-inch Speed Hump.



ASPHALT OR LANDING MAT WITH RAMPS OVER DIRT FILL

FIGHTING POSITIONS.

This section provides basic information on the siting and construction of fighting positions; it also builds on information previously identified regarding revetments and berms and provides protection criteria and cautions for construction.

Hasty Natural. A hasty, natural fighting position uses existing holes/depressions, rocks, and logs, to provide a position with frontal and possible side (flank) protection (figure 71). No digging is required.

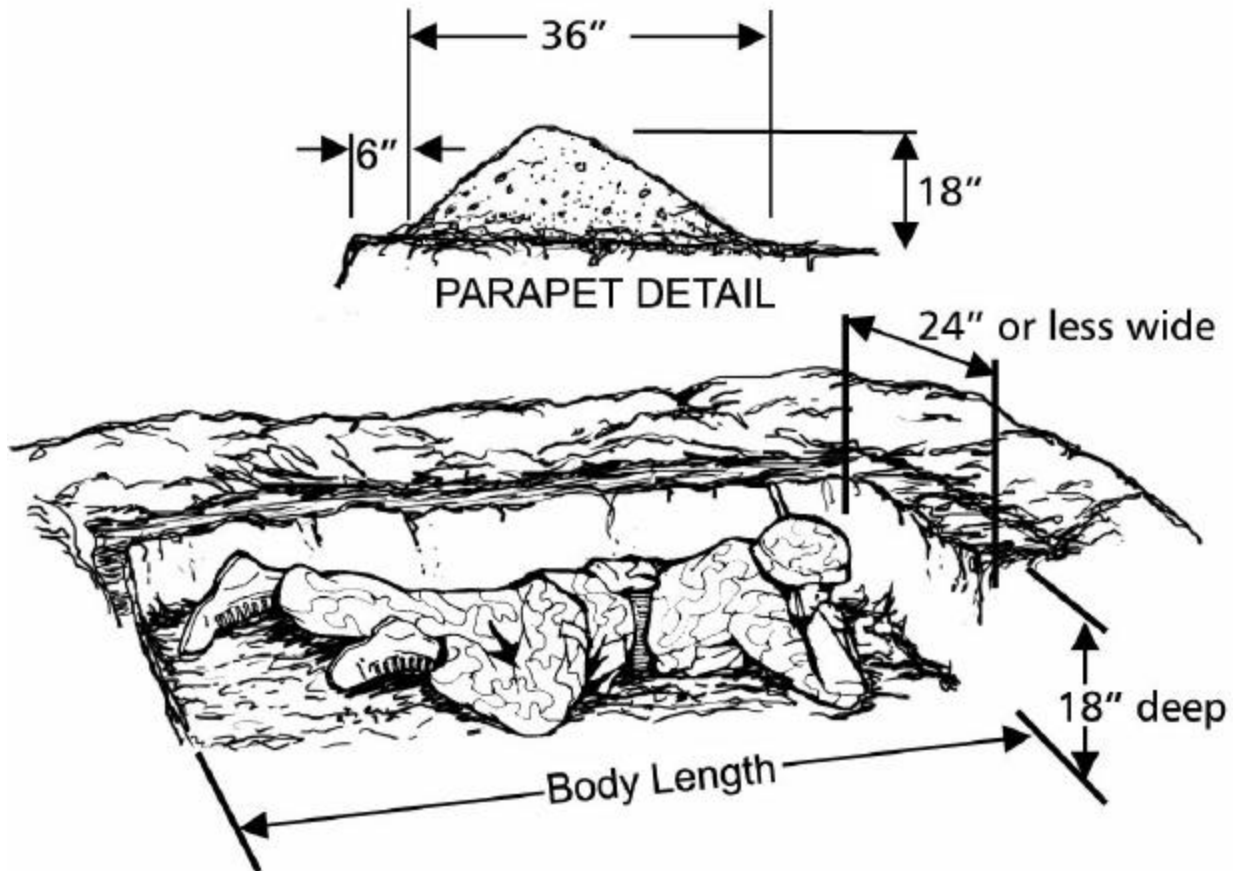
Figure 71. Hasty Natural Fighting Position.



Hasty Augmented. A hasty, augmented fighting position (figure 72) uses existing frontal and side (flank) covers. It is normally constructed by using hand tools to dig in to about an 18-inch depth. Some of the existing natural

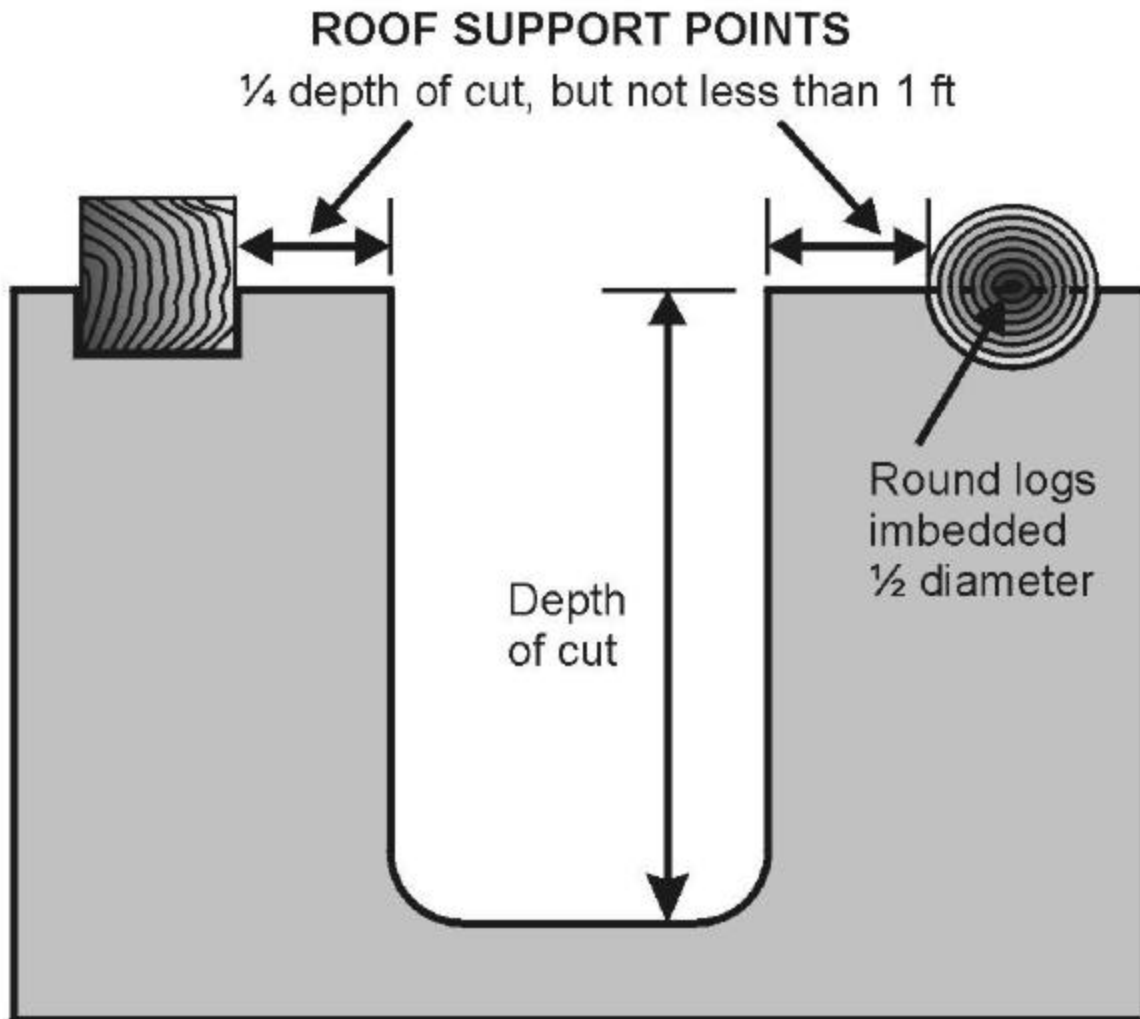
cover may be moved or better incorporated for protection and concealment. Often the position is run at an oblique angle facing toward the enemy and the facing side is built up with a low parapet of spoil material. Spoil dirt can be used to enhance cover and an opening made in it for firing of weapons. If the soil is stable, then the dug or scraped walls can be sloped at a 3:1 or 4:1 (Vertical to Horizontal) slope for use without revetting to prevent collapse.

Figure 72. Hasty Augmented Fighting Position.



Deliberate. A deliberate fighting position is generally a hasty augmented position that has been further hardened and **enhanced by adding overhead cover**. If the initial hasty position was oblique to the enemy's approach, the deliberate fighting position should be reoriented to face the enemy more squarely. When building an overhead cover, make sure that bearing support beams are properly positioned (figure 73). Normal setback of the bearing beam from the top edge of the fighting position is at $1/4$ the depth of the fighting position (i.e., $1/4 V$, where V is the depth of the fighting position). Unless required to be different for special equipment or weapons support, the depth of the fighting position is armpit deep. Camouflage is normally required to conceal the surrounding protection and cover. The standard for checking detection of a fighting position is to make the position unobservable from 35 meters (38 yards). This means that the position should blend in with its surroundings. Trenching may be used to connect fighting positions to allow personnel to crawl or move between positions. Drainage of the structures can be very important in wet climates or if there is seepage from higher ground water tables.

Figure 73. Spacing of Bearing Support Beams for Overhead Cover.



When upgrading to a deliberate fighting position, the wall faces should be reinforced if conditions and the situation dictate. Reinforcing the sides of fighting positions is extremely important for fighting positions that will be constructed in poorly compacting soils or will experience ground shock from high explosive shells or bombs. To prevent ground shock from collapsing the faces of a fighting position, the face of the earth walls must be reinforced (i.e., revetted) with some structural facing system, cut at an angle that is not vertical (i.e., sloped), or both. It is preferable to revet a position rather than have a much larger position with gently angled wall slopes. When constructing overhead cover, it is very important to minimize the unsupported roof span length. This usually is very difficult to achieve if wall faces are only sloped and not revetted.

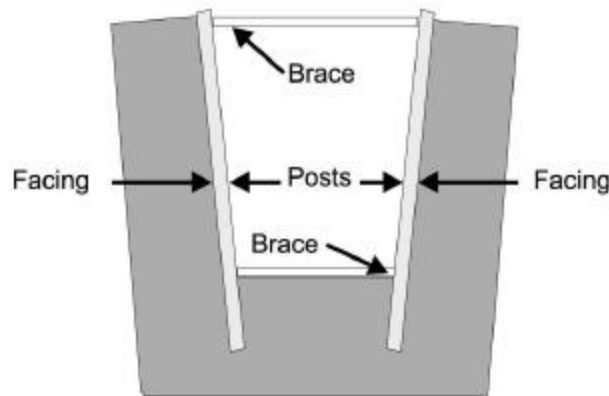
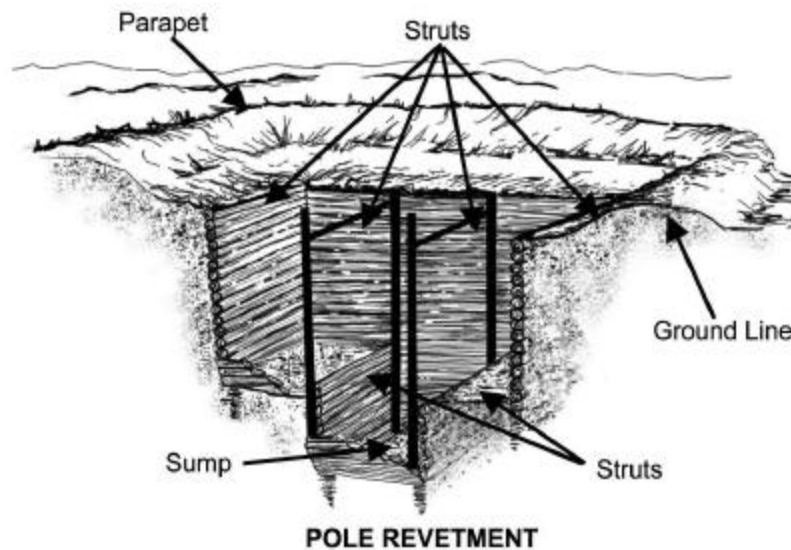
Example: A fighting position must be 4 feet deep and will be located in a sandy gravel soil. The position must be made deliberate with an overhead cover. It is not possible to dig a hole with vertical faces in dry sand, gravel, or silty sand, as the material would simply fall back into the hole. Without revetting material on the sides of the hole, to obtain a 3-foot wide hole at the bottom the fighting position may create a hole that is 12 feet wide at the top. This very wide span would prevent the use of all standard wood support members and would require the use of special wood or steel joists, structural steel members, or steel trusses for supporting

overhead cover. However, by using revetting materials, the top of the hole would be only about 5 feet across, which would allow the use of common lumber (i.e., 2 x 4s and 2 x 6s) for constructing an overhead cover.

Revetting is also critical for some soils with a large amount of clay or high plasticity, as these soils may *liquefy*, displace, or shear from ground shock. A task qualified Engineering Journeymen (3E551), who has practice and additional experience in soil testing, may be able to perform expedient tests for field classification of soils found in Attachment 2. The procedures should be used to determine the soil types present in a deployed area where expedient construction is required for revetments, berms, and fighting positions.

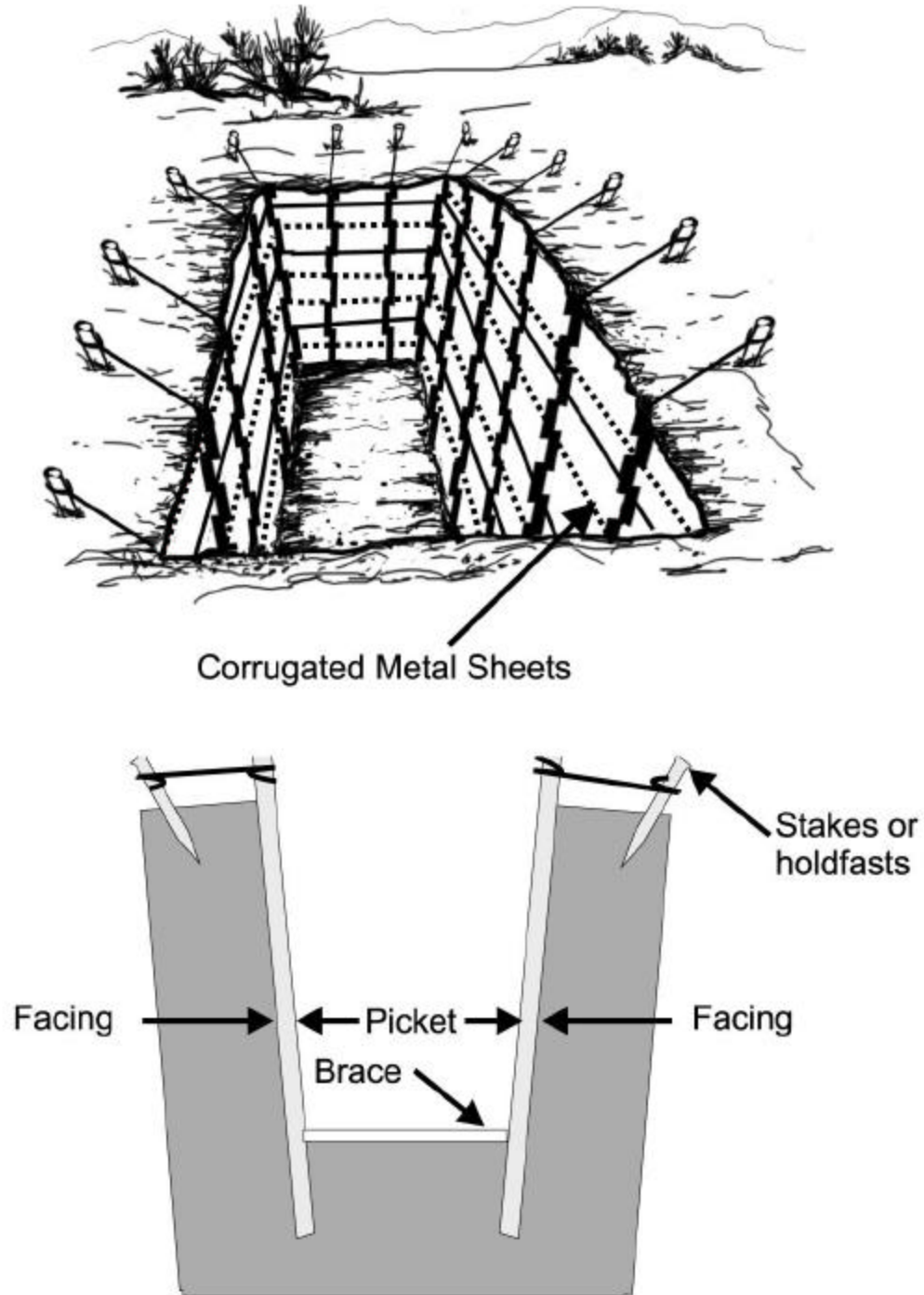
Revet the soil faces of a fighting position by using facing material held in place with either braced (figure 74) or tied pickets (figure 75). Pickets can be lumber, wooden poles, standard concertina wire pickets, metal poles, angular posts, or trees. Wooden pickets from trees or saplings should be at least 3 inches in diameter. The pickets hold a facing material (i.e., usually plywood, landing mats, corrugated metal, timbers, brushwood mats, lumber, wire mesh, geotextile fabric, or cloth mat) against the soil face.

Figure 74. Facing Material Braced.



FACING REVETMENT SUPPORTED BY TIMBER FRAMES

Figure 75. Facing Material Held with Stakes.



The spacing of pickets depends on the soil conditions and the facing material. For matting type systems (i.e., brushwood mats, wire mesh, geotextile fabric, or cloth mat), the picket spacing should not exceed 30 inches. For more rigid facing material (i.e., corrugated metal sheets, landing mats, and lumber), the picket spacing may be up to 78 inches. The pickets should be driven into the ground at least 18 inches. When stakes are used to tie back and hold the pickets in place, the stakes should be located at a horizontal distance (H) away from the edge of the excavation, which is equal to the vertical depth (V) of the excavation. If more than three or four pickets are to be used on a soil face, then the stakes should be alternated such that every other stake is located $H_0 = H + 2$ feet farther away from the excavation (figure 76).

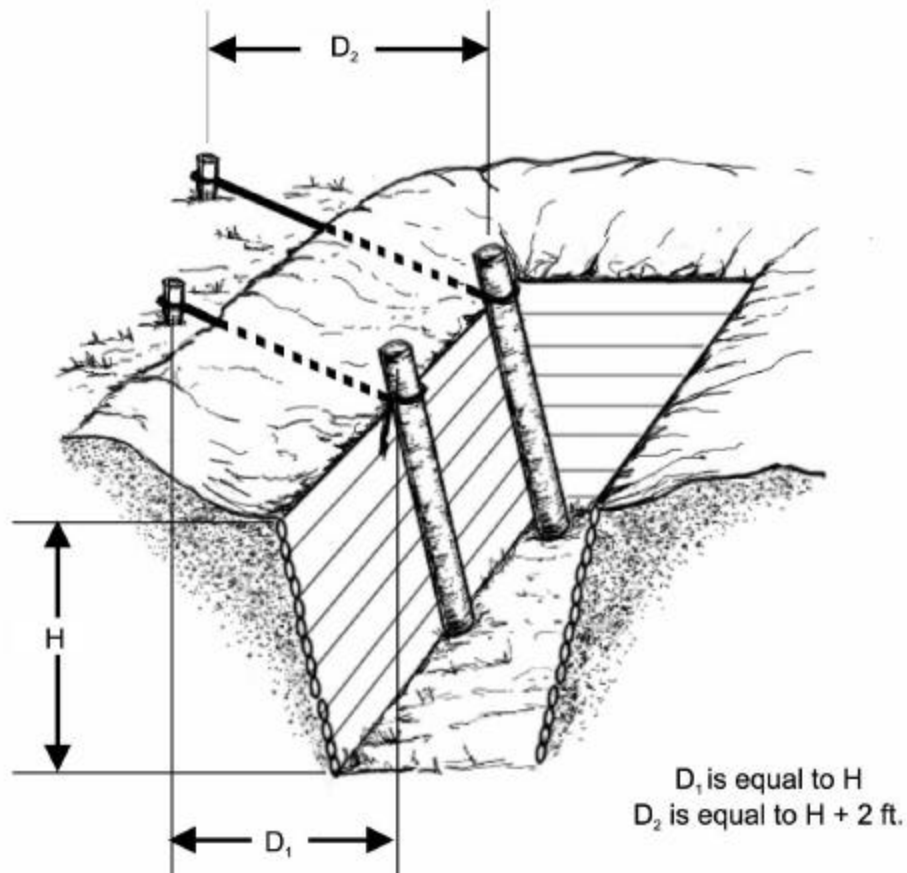
Preventing Ground Shock Collapse. Fighting positions can be subjected to **high levels of ground shock** when located in areas where certain soil or geological conditions exist. Ground shock sufficient to collapse a fighting position can occur when positions are constructed:

Over a water table that is close to the bottom of the fighting position or

In areas where the soil is located within about 25 feet of and over an underlying rock formation, moist clay layer, or soil with higher water content.

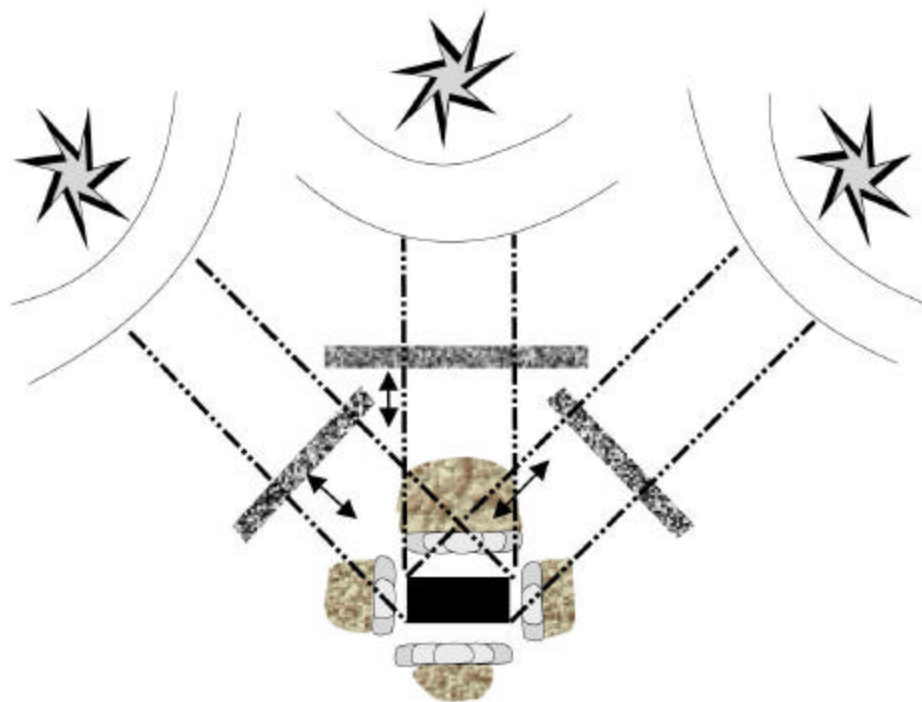
The ground shock is intensified by reduced resistance through the soil or reflection from the underlying soil and rock formations. Civil Engineers need to be aware of the soil types and general geology present in areas that will have fighting positions.

Figure 76. Staggered Stake Bracing of Pickets.







When it is determined by Civil Engineers that fighting positions are to be constructed in areas more susceptible to ground shock and Security Forces know that counterattacks will occur with high explosive shells, then **additional ground shock protection should be considered**. One of the best forms of protection against ground shock is to dig narrow trenches to intercept the ground shock wave. Dig the trenches approximately 12 inches wide to a depth where the bottom of the trench is at least two feet deeper than the depth of the bottom of the fighting position. The trenches should be at least six feet longer than the width of the exposed fighting position dimension that will be protected. This will allow about 3 feet of trench to extend beyond the exposed fighting position dimension. Locate the ground shock intercepting trenches at locations between the fighting position and the most likely impact points for the high explosive shell. Locate the trenches away from any berming or sandbags of the fighting position at a horizontal distance approximately 1.5 to 2 times the depth of the trench. See figure 77 for illustration of locating the trenches in relation to the fighting positions. The placement of fighting trenches and log standoffs is quite similar in that each is positioned to intercept either ground shock or incoming rounds.

Figure 77. Placement of Ground Shock Intercepting Trenches.



FIGHTING POSITION (FP) WITH SANDBAGS AND SPOIL BERMS

-  Ground shock intercepting trenches
-  Expected locations for HE shells and shock waves
-  Edge boundaries of FP for figuring trench overlap
-  Distance "D" between trench and berms is 1.5 to 2 times the depth of trench

While trenches used to crawl or move between fighting positions and other key locations should be reinforced against collapse from ground shock, **ground shock intercepting trenches are not reinforced**. They are meant to collapse and thereby *absorb* enough of the ground shock to prevent the fighting position from collapsing. Because

of their narrower width and shorter lengths, they may be more readily camouflaged from detection than connecting trenches.

Placement of Overhead Cover, Protection Walls, and Grenade Sumps. When constructing overhead cover and protective walls, follow these two rules for use of fighting positions.

Rule 1: Fighting positions are to be camouflaged to prevent being seen by ground and aerial reconnaissance.

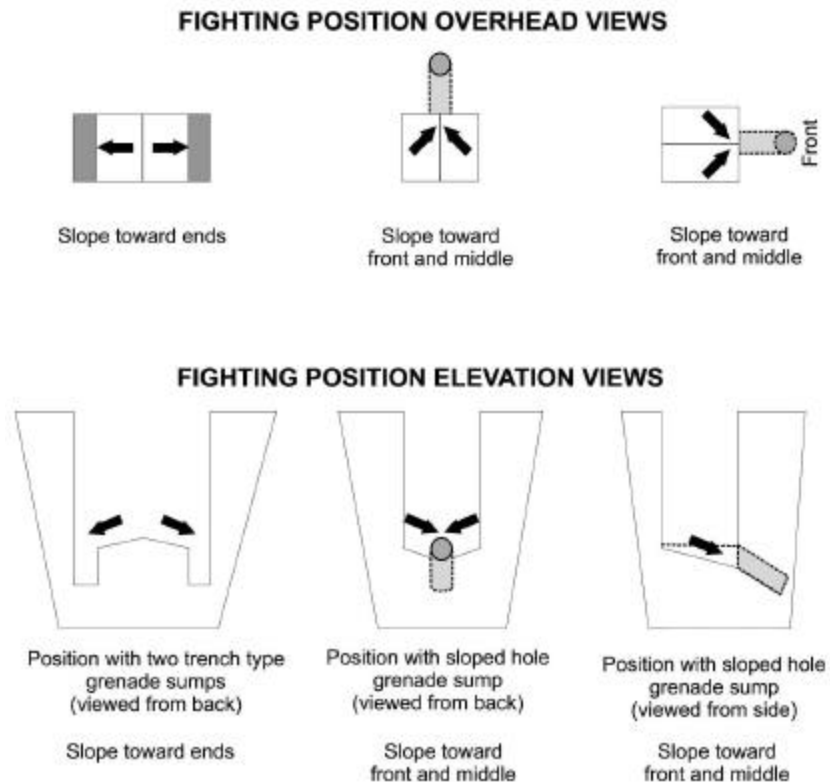
Rule 2: When a fighting position has opened fire, the position should provide protection from return fire.

Overhead cover: Unless designing cover to defeat a specific weapon, plan on providing at least 18 inches of sandbagged or contained soil cover for the fighting position. The cover platform should be about 24 inches wide (minimum) for the 1-person fighting position and at least 30 inches wide for larger positions. The overhead cover normally runs from front to back and is located across the middle of the trenched position, but a smaller 1-person position may have overhead cover that runs from side to side.

Protection Walls: For deliberate positions, the spoil dirt from the fighting position should be piled starting about 12 inches outside of the front, rear, and side walls of the position to provide protective walls. If possible, sandbag and stack most of the soil, placing loose soil in front of the bags for concealment purposes and additional protection. The front and flank (side) walls should be at least 12 inches to 18 inches high, while the rear wall may be about 6 inches lower. The walls are designed for protection from weapons fire. The walls are not to be designed for protection from moisture from runoff. Surface drainage must be diverted away from or intercepted before it gets to the position. While they can prevent water intrusion, the walls would be eroded and/or degraded by surface drainage, especially if sandbags are not used.

Grenade Sumps: The placement of grenade sumps depends on the position being constructed (figure 78).

Figure 78. Typical Grenade Sumps.



For a small, 1-person fighting position, the grenade sump should be dug as a small hole, especially if the fighting position does not have overhead cover. Dig the hole about the width of the trenching tool shovel and the length of the tool into the bottom front face of the position. It should be dug forward and angled downward about a foot. Dig the floor so that it slopes toward the hole and makes it easy to kick a grenade into the sump. The fighting position should be dug large enough (i.e., at least 2 feet from front to back) so that the blast goes into the back wall clear of your back and legs.

For rectangular or curved positions, the sumps are normally dug with an entrenching tool and are dug as small trenches about the width of the entrenching tool's shovel and as deep as the tool is long. Place the grenade sump trenches at the ends of the fighting position to allow the blast to go straight up and let you move toward the other end of the trench. Slope the floor (within 3 feet of the end of the trench) toward the grenade sump to make it easier to kick the grenade into the sump. When possible, try to avoid placing the grenade sumps under overhead cover, especially if the cover is set across the middle of the trench. The blast could not only reflect off the cover, but could also collapse the structure.

Example: If a 1-person fighting position is about 4 feet wide and has a 24-inch wide overhead cover on one end, then dig the grenade sump trench on the end opposite the cover and slope the trench floor toward the trench.

A combination of grenade sump trenches and holes can be used for special purpose fighting positions that may be shaped differently than a standard 1- or 2-person position. A T-shaped position that provides a position for additional observation or firing zones may require additional grenade sumps. Just make sure that the blast from the sump is not directed toward personnel in other sections of the fighting position.

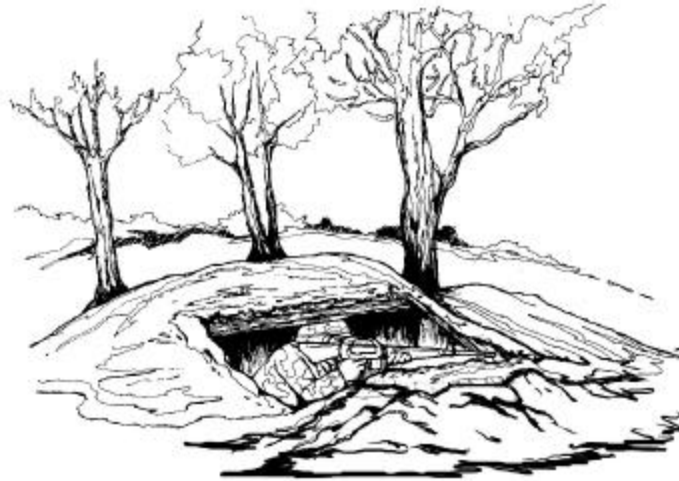
When a position must be fully revetted due to poor soil conditions, even the grenade sump may have to be lined (as illustrated in the top portion of figure 74). In this case, the reinforced floor should be slanted toward the sump and the blast from the sump directed away from areas where personnel may take cover.

Basic information and illustrations for deliberate fighting positions with cover:

1-Person Fighting Position. The 1-person fighting position should be at least 36 to 39 inches wide (i.e., about the width of an M-16A2 rifle) and about 2 feet from front to back (i.e., about two helmet lengths wide). While it can have continuous protective (parapet) walls around the front and sides, this type position is usually built with a narrower front wall for cover and to allow the user to observe and fire around the front wall. Plan on providing a front parapet about 24 to 30 inches wide and having a parapet around the side and back. Usually only one grenade sump hole is required.

When the position is limited to the above size, providing top cover may greatly limit quick entry, exit, or the ability to fire. Sometimes terrain or cover make it more advantageous to keep the width of the position to a minimum, while at other locations, it may be better to extend the width of the position so it can incorporate a tree or boulder for protection or cover. When the width of the position must be minimal, the front to back distance may have to be increased to 3 feet or larger to allow the overhead cover to be run from side wall to side wall, as shown in figure 79. If the position needs to be extended wider, then the top cover may be located across the middle from the front wall to back wall.

If personnel will have to remain in their positions for long periods of time or must support several mission functions, such as to provide firing and observation/control, then additional supplies may be required. Size the positions to meet the additional space required for supplies and storage, such as for more ammunition, rations, water, and communications equipment.

Figure 79. 1-Person Fighting Position (Deliberate).

2-Person Fighting Position. When two personnel are using rifles in a fighting position, the positions usually use one of two basic shapes. The generally used position is rectangular; figure 80 shows a straight position (with the top cover ghosted in). For quick digging and short-term use, the position may be as small as 6 feet wide and 2 feet from front to back. However, for functionality or for longer-term use, the position should be about 7 feet wide and 3 feet from front to back. When a firing position must provide additional covering fire for an adjacent firing position or to cover dead space in close terrain, then the rectangular position is modified by extending one or both ends forward at about a 45-degree angle to provide a wider sector of fire. Figure 81 shows an extended position (with top cover ghosted in). Because of its increased width and visibility, these positions provide a better target for hand grenades; two grenade sump trenches are required, one at each end of the fighting position. A central grenade sump may be dug into the front of the wall.

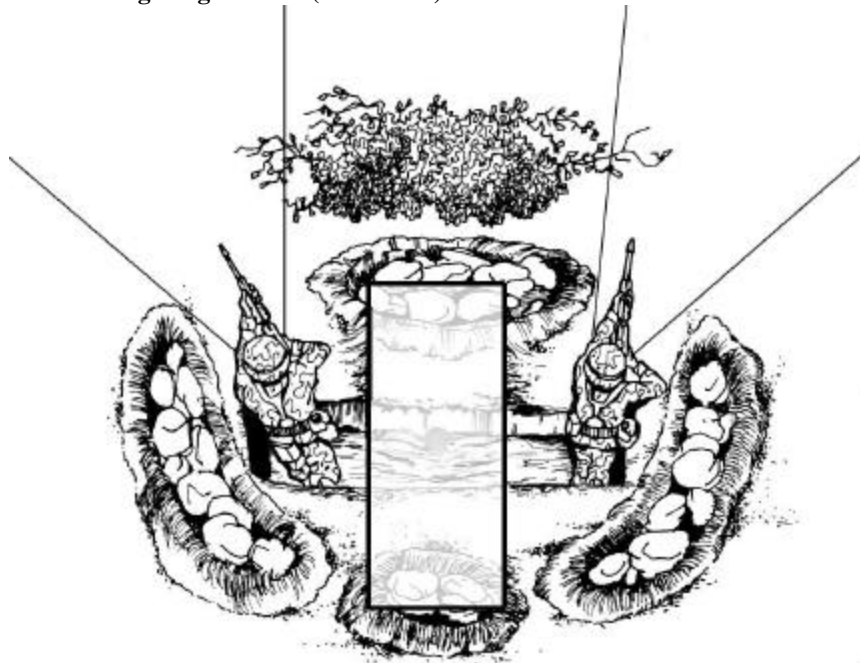
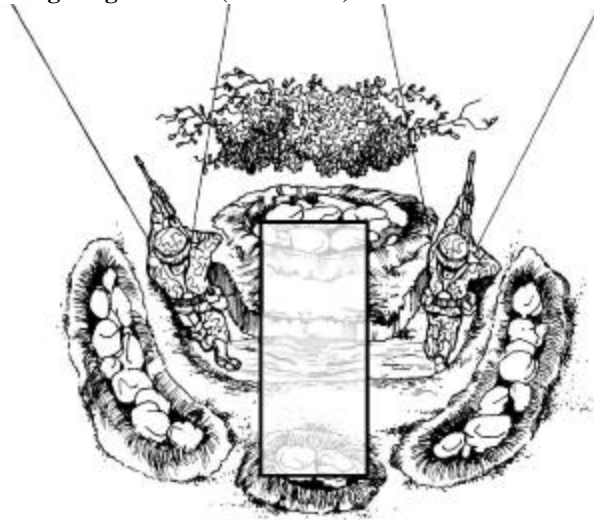
Figure 80. Straight 2-Person Fighting Position (Deliberate).

Figure 81. Extended 2-Person Fighting Position (Deliberate).



Machine Gun Fighting Position. A machine gun position (figure 82) is similar to a large, straight 2-person position, except it may be widened and have a ledge type platform on the front face of the fighting position at each of the two firing locations. The ledges provide a stabilized platform for the placement of the machine gun's tripod and/or biped legs. The height of the ledge and the firing sectors are predetermined and aiming stakes may be used for the sectors of fire, to allow firing without exposing the crew. Like the 2-person position, the machine gun fighting position is a more observable and a better target for hand grenades. A grenade trench is built at the rectangular ends by both platforms and another trench angled into the wall between the two platforms. Angle all floor surfaces toward the grenade sump.

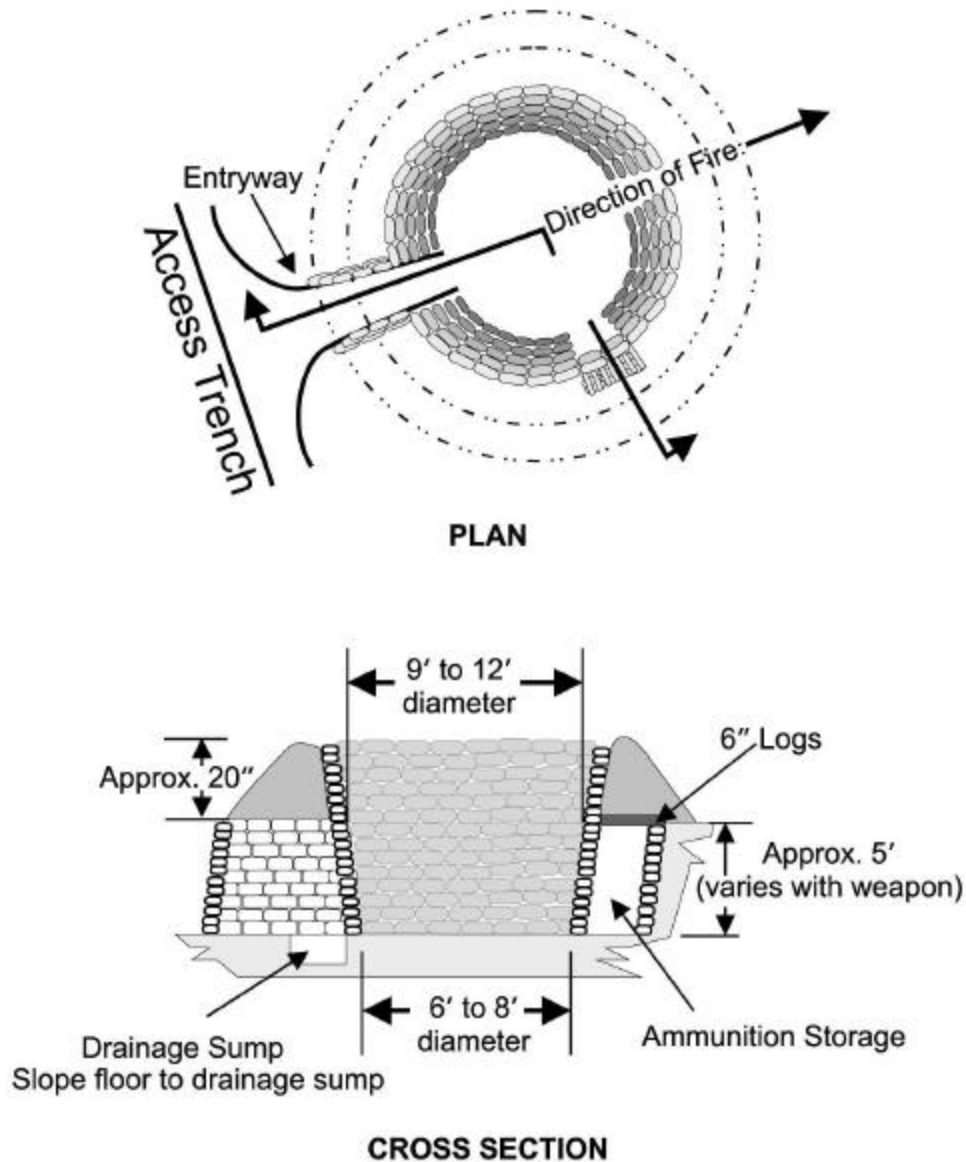
The position may be built to accommodate three persons, such as a spotter or ammunition carrier, by having the back middle of the fighting position (under the overhead cover) extended to the rear by about the size of a small 1-person position. This provides for an overall T-shaped design; the back position may also be used for additional firing positions or storage. If a position needs to be established for additional coverage of several sectors and a machine gun is unavailable, a 3-person team with rifles can use the T-shaped design.

Figure 82. Machine Gun Fighting Position (Deliberate).



Mortar Position. If base defenders will require mortar positions, Civil Engineers may have to help with the construction. The mortar position (figure 83) is circular in shape; the size varies based on the mortar system being used. Typically the mortar position is from 6 to 8 feet in diameter at the bottom, about 5 feet deep with a 20-inch high berm.

Figure 83. Mortar Crew Fighting Position.



The **actual depth** of the position depends on the height of the mortar and crew -- the position must be deep enough to protect the weapon and crew, but not restrict the crew from aiming alignment. The walls of the position are sloped outward (for clearance and stability) and revetted with sandbags or other protective facing material to prevent caving in from repeated launch concussions. The upper diameter of the position can be 9 to 12 feet in diameter, again depending on size of the mortar and clearances required for aiming alignment.

There is no overhead cover for a mortar position and the position is less easily camouflaged. This fighting position uses a trench system for entry and requires a separate position for crew protection. A trench leads from the back of the mortar position away from the direction of fire; it extends for a short distance straight back from the position before turning at a 90-degree angle into an access trench to a covered position or other location. The entrance trench should be revetted to prevent collapse. Reinforced, protected racks for storage of mortar rounds are normally built into the sidewall of the mortar position (just above the floor) and into walls of the adjoining trenches. Since the position is open to the elements, the position normally requires a drainage sump near the entrance trench. Slope the floor uniformly toward the sump. If the sump is built deep enough, it can also function as a grenade sump, but should have additional slope near the sump to help direct a kicked grenade into the sump.

Light Antitank Weapon (LAW) Fighting Position. While the LAW could be fired from other fighting positions, dedicated LAW positions (figure 84) are located and designed to accommodate the backblast from the weapon. Site the position such that the area to the rear of the firing area is away from trees, walls, parapets, or loose gravel that could deflect the backblast or blow debris from the backblast toward other fighting positions and personnel.

The LAW fighting position should be about the size of a large, straight 2-person fighting position and have overhead cover located at one end of the fighting position. At the other end of the fighting position, the LAW gunner position may have a small platform for elbow rests cut into the top of the wall; the front face of the position should be inclined forward for better stability of the gunner. If frontal protection is needed at the gunner's position, it should be minimal and stabilized. If there is raised rear protection, it must be low enough to ensure that the blast is not diverted toward another fighting position or back at the LAW gunner. Also make sure that the rear wall of the fighting position is not too high for the full range of fire for the LAW, as the blast could be entrapped in the fighting position for elevated shots. Grenade sumps can be located at both ends of the position.

Figure 84. LAW Fighting Position (Deliberate).



Special Design. Positions that provide for greater protection of personnel and equipment, especially where the surrounding soil or terrain provides little natural protection or cover, may sometimes have to be constructed. Civil Engineers and equipment are required to provide heavy equipment and structural work to place heavy wood or steel framing, additional sandbags, berming, rock or rubble, earth cover, and/or concrete modular or precast concrete

revetment sections. For these type designs, which are typically much more observable than fighting positions, CCD becomes a major consideration for protection from the ground and aerial reconnaissance.

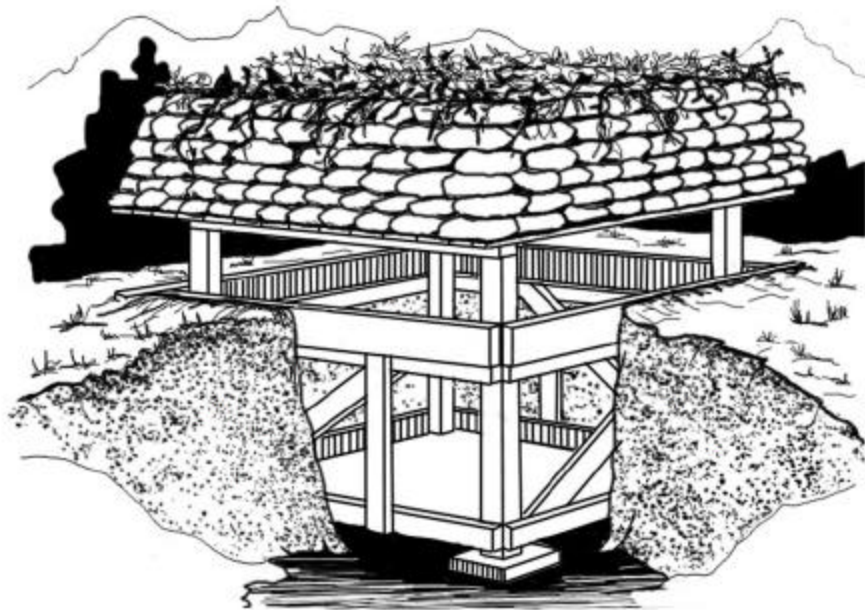
Wood-Framed Fighting Position. The wood-framed fighting position (figure 85) is a position that can be constructed using commonly available materials equivalent to 6 x 6, 2 x 8, and 3 x 12 lumber and plywood. It will provide a raised, heavily sandbagged and soil reinforced overhead platform cover for a semi-buried structure. The semi-buried structure provides a 6.5-foot wide by 4.5-foot long by 6-foot high area for 2 personnel to use as a fighting position. About 4.5 feet of the structure is buried to provide a 1.5 foot high area of fire. These type structures can be made with commonly available commercial wood and steel members and fasteners.

If these structures will be used at a deployed location, the design for these structures should be copied or downloaded (prior to deployment) from the diagrams found in AFPAM 10-219, Volume 2. However, the structures can be field engineered by using Tables 11 to 14 from this handbook and by using column and framing cross members of 6 x 6 and 2 x 8 structural lumber, 3-inch diameter heavy steel pipe, and/or 3 x 3 steel angles (as a minimum). For additional protection, stack sandbags at the corners to protect the support columns from damage. Ensure that there are bearing plates under the columns. Also design the structure to have dug earth faces for the semi-buried portion of the structure.

If the earth is highly stable and incoming weapons will only be small arms fire, then the earth face may be dug freestanding and slightly recessed away from the structure.

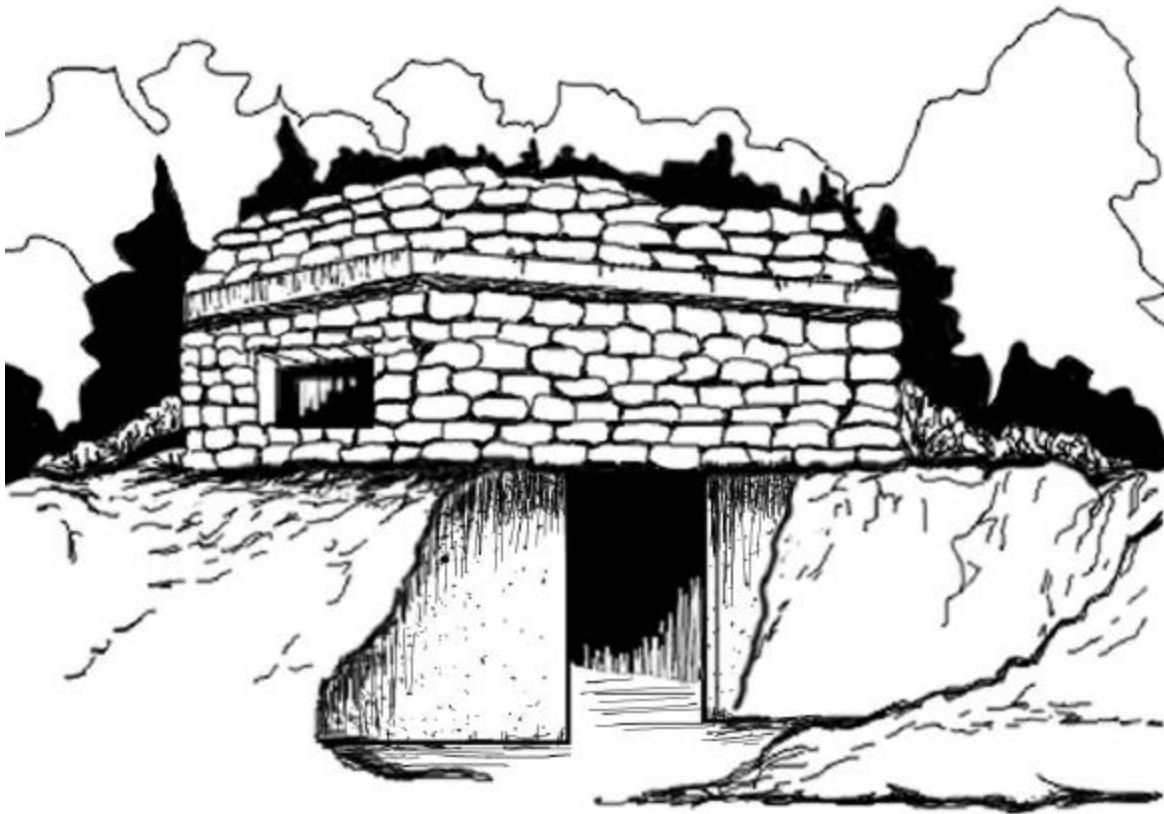
If the earth is less stable or more than just small arms weapons fire will be encountered, then the earth face should be dug and revetted with a retaining wall and either tied or braced by additional supports within the structure.

Figure 85. Wood-Framed Fighting Position.



Reinforced Bunkers. While technically not a fighting position, a reinforced bunker is a large position that provides long-term support for several teams of security forces in a hardened position, which is reinforced against direct- and indirect-fire. Tunnels and trenches may be constructed to connect with other fighting positions. Extensive engineering support is required for positioning or working with: rock and reinforced concrete for burster protection, structural concrete walls and beams, concrete or earth filled revetments, large lumber, heavy gauge or structural steel members, and/or sheathing. The positions may be either aboveground or belowground construction. By burying the lower floor or making it semi-buried, reinforced bunkers can be expediently built by Civil Engineers using precast concrete revetments and retaining walls (figure 86). Again, these systems can be field engineered using Tables 11 to 14 and using commercially available retaining walls or concrete revetments.

Figure 86. Precast Concrete Slab Bunker.



MICHAEL E. ZETTLER, Lt General, USAF
DCS/Installations & Logistics



ATTACHMENT 1

ARRANGEMENT PATTERNS FOR REVETMENTS AND BERMS.

When deciding on which specific type of revetments will be used to protect an asset (whether it is an aircraft, a facility, or a piece of equipment), consider that there are some similarities in the placement of the revetment. Two major considerations are:

- Access to the asset and
- Protection of the asset from unauthorized access and blast/fragmentation.

Providing access to users should not conflict with preventing access by intruders and exposure to blast and fragmentation.

Following are general figures that depict the basic placement of revetments and assets (figure A1.1). Except where the asset is a parked aircraft, almost every revetment is designed to prevent straight-in access to an asset. During siting, even aircraft revetments should consider having some form of a blast-deflecting revetment built directly across the taxiway from the aircraft.

Basic principles for siting large structural revetments for protection from bomb blast are:

Align revetments to prevent blast and fragmentation from a nearby detonation from passing through an access route or entrance area directly to an asset.

Extend the revetments far enough past the asset to cut down the angles of exposure.

Where revetments are not connected, create an overlap between revetments to prevent direct line-of-sight (and therefore direct access for the blast).

When ends of large structural revetments can not overlap, such as at entrance corners (figure A1.2), make sure that there is an alternative way of blocking blast. Use portable concrete revetments and/or sandbagged revetments to cut off the line-of-site by creating an angled entry at the corner or creating a 90-degree bend in the access route (details Options 1 and 2).

When the angle(s) of exposure for an asset can not be decreased, such as for an aircraft in a revetment (figure A1.3), ensure that camouflage and deception plans do not place decoys in areas within the angle(s) of exposure.

Figure A1.1. General Placement of Berms and Revetments.

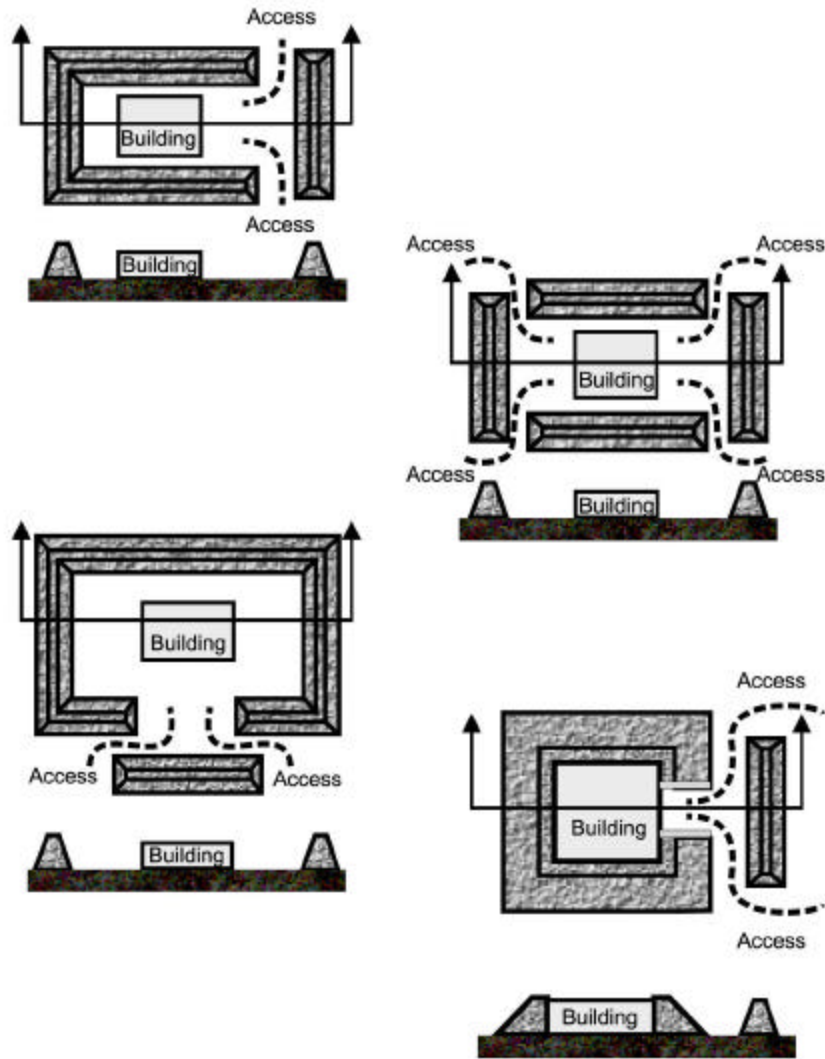


Figure A1.2. Use of Expedient Revetments at Corner Entranceway.

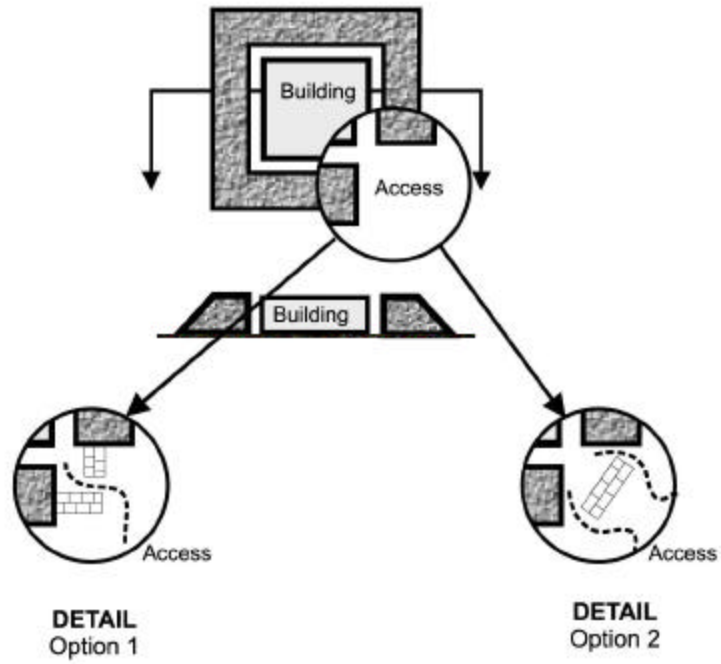
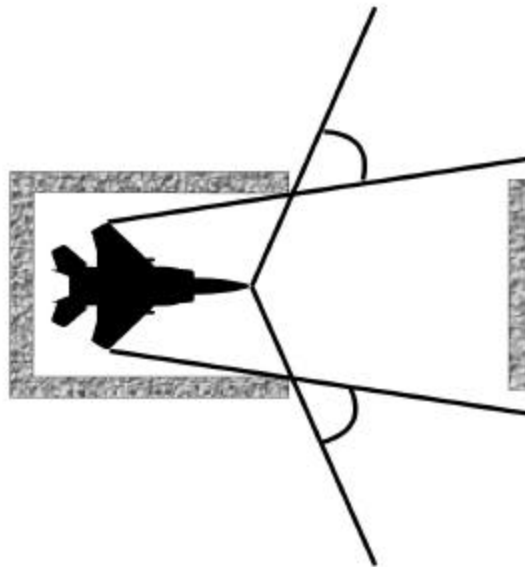


Figure A1.3. Determining Angle of Exposure for Revetments.



ATTACHMENT 2

TESTS FOR FIELD CLASSIFICATION OF SOIL

The following tests provide observations that permit field identification of soil samples. The tests are based on AFJMAN 32-1034 and FM 5-410 Chapter 5; the tests have been organized for expedient field testing of soil. Most tests can be performed without laboratory test equipment, except that **using No. 40 and No. 200 sieves will provide much better accuracy and will speed up testing**. While the visual examination may be of a larger amount of soil, the tests can normally be run with about a pint of soil (i.e., about a full canteen cup). The soil sample(s) should be taken from the levels of soil that will be exposed during construction and are related to the structural strength of the construction. Therefore, if the soil needs to be tested for a fighting position, the sample should come from the exposed wall material that will be a part of the structure and not the topsoil layer.

Visual Examination. A visual examination can be used to establish the color, grain sizes, grain shapes of the coarse-grained portion, some idea of the gradation, and some properties of the undisturbed soil.

Color. Color helps in distinguishing between soil types, and with experience, aids in identifying the particular soil type. Color may also indicate the presence of certain chemicals or impurities. Colors in general become darker as the moisture content increases and lighter as the soil dries. Some fine-grained soil (OL, OH) with dark, drab shades of brown or gray, including almost black, contain organic colloidal matter. Clean, bright shades of gray, olive green, brown, red, yellow, and white are associated with inorganic soils. Gray-blue or gray-and-yellow mottled colors frequently result from poor drainage. Red, yellow, and yellowish-brown result from the presence of iron oxides. White to pink may indicate considerable silica, calcium carbonate, or aluminum compounds.

Grain size. The maximum particle size of each sample considered should always be estimated. Gravels range down to the size of peas, about 1/4 inch (i.e., materials retained on a No. 4 sieve). Sands start just below this size and decrease until the individual grains are just distinguishable by the naked eye. The eye can normally see individual grains about 0.07 millimeter in size (about the size of the No. 200 sieve). Silt and clay particles, which are smaller than sands, are indistinguishable as individual particles.

Grain shape. While the sample is examined for grain sizes, the shapes of the visible particles can be determined. Sharp edges and flat surfaces indicate angular shape, while smooth, curved surfaces indicate rounded shape. Particles may not be completely angular or completely rounded. These particles are called subangular or subrounded, depending on which shape predominates.

Distribution of grain sizes. While laboratory analysis is needed to determine accurate distribution, an approximation can be made by field examination.

Separate the larger grains down to about 1/8th inch and larger (gravel and some sand particles) from the remainder of the soil by picking them out individually.

Examine the remainder of the soil and estimate the proportion of visible individual particles (larger than No. 200 sieve) and the fines (smaller than No. 200 sieve).

Convert these estimates into percentages by weight of the total sample.

If the fines exceed 50 percent, the soil is considered fine-grained (silt--M, clay--C, or organic--O).

If the coarse material exceeds 50 percent, the soil is coarse-grained (gravel--G or sand--S).

Examine coarse-grained soil for gradation of particle sizes from the largest to the smallest.

If there is a good distribution of all sizes, this means the soil is well-graded (W).

If there is an overabundance or lack of any size, this means the material is poorly graded (P).

Estimate the percentage of the fine-grained portion of the coarse-grained soil.

If less than 5 percent (non-plastic fines) of the total, the soil may be classified either as a GW, GP, SW, or SP type, depending on the other information noted above.

If the fine-grained portion exceeds 12 percent, the soil will be either M or C and requires further testing to identify.

If the fine-grained portion is between 5 and 12 percent (non-plastic fines or fines not interfering with free drainage), the soil is borderline and requires double symbols such as GW -GM or SW -SM.

Fine-grained soils (M, C, or O) require other tests to distinguish them further.

Undistributed soil properties. Using characteristics determined up to this point, evaluate the soil as it appeared in place. Gravels or sands can be described qualitatively as loose, medium, or dense. Clays may be hard, stiff, or soft. The ease or difficulty with which the sample was removed from the ground is a good indicator. Soils that have been cultivated or farmed can be further evaluated as loose or compressible. Highly organic soils can be spongy or elastic. In addition, the moisture content of the soil influences the in-place characteristics. This condition should be recognized and reported with the undisturbed soil properties.

Sedimentation Test. The visual observation test is used to approximate the proportions of sand and gravel in a soil by spreading the dry sample out on a flat surface and separating the gravel particles by hand. **When No. 40 and No. 200 sieves are not available**, separating the fines from the sand particles is achieved by the sedimentation test. Place a small amount of the fine fraction of soil, such as a heaping tablespoon, in a transparent container, such as a jar. Break up any lumps of soil (especially the clays) by grinding the soil in a canteen cup with an improvised wood pestle and add back to the container. Cover the sample with about 5 inches of water and agitate by stirring or shaking. The soil particles will settle out in the time periods indicated in Table A2.1.

Table A2.1. Sedimentation Test Settling Times.

Approximate time of settlement through 5 inches of water	Grain diameter (mm/ inch)	Differentiates
2 seconds	0.4/ 0.0157	Coarse sand -- fine sand
30 seconds	0.072/ 0.0028	Sand -- fines
10 minutes	0.03/ 0.00118	Coarse silt -- fine silt
1 hour	0.01/ 0.00039	Silt -- clay

The test will differentiate the coarse fraction from the fine fraction of a soil. *The coarse materials are larger than 0.4 mm and would be retained on a No. 40 sieve. Fine sands fall between 0.4 mm and 0.7 mm. The fine materials will be less than 0.072 mm and would be material passing a No. 200 sieve.* To obtain the fines, wait 30 seconds after shaking and then gently pour the liquid with suspended fines into another container. Add additional water to the original container and shake again. Repeat the above process with the just used sample, again waiting 30 seconds and pouring the clearer liquid into the second container. Repeat until the liquid appears clear. Pour the water with the fines into a flat pan; dry the soil in the container (i.e., the sand) and the soil in the pan (i.e., the fines) by letting the water be wicked or evaporated off. Determine the relative amounts of fines and sand.

Note: For the numerous tests that require use of all fines (i.e., the fines and fine sand materials passing a No. 40 sieve), the above procedure can be modified to provide this test material. Take a sample of the original material and separate out the gravel particles by hand. Place a small amount of the fine fraction of soil in a transparent container and break up any lumps of soil (especially if clay) by grinding the soil in a canteen cup with an improvised wood pestle and add back to the container. Cover the sample with about 5 inches of water and agitate by

stirring or shaking. Between 1 and 2 seconds after stopping the agitation, pour off the water with the suspended materials into a flat pan and dry the soil. The soil in the pan will contain particles in the fine and fine sand range.

Breaking or Dry Strength Test and Powder Test. Perform these tests only on material passing the No. 40 sieve. Prepare a pat of soil about 2 inches in diameter and 1/2 inch thick by molding it in a wet, plastic state.

Allow the pat to dry completely, then grasp the pat between the thumbs and forefingers of both hands and attempt to break it. See Figure A2.1 for the proper way to hold the pat. If the pat breaks, perform the Powder Test by taking a portion of the broken pat and rubbing it with the thumb in an attempt to flake particles off.

Figure A2.1. Proper Handling for Breaking or Dry Strength Test.



The results of these tests indicate the following:

If the pat cannot be broken nor powdered by finger pressure--Very highly plastic soil (CH).

If the pat can be broken with great effort, but cannot be powdered--Highly plastic soil (CL).

If the pat can be broken and powdered, but with some effort--Medium plastic soil (CL).

If the pat breaks quite easily and powders readily--Slightly plastic soil (ML, MH, or CL).

If the pat has little or no dry strength and crumbles or powders when picked up--Non-plastic soil (ML or MH) or (OL or OH).

Note: Dry pats of highly plastic clays quite often display shrinkage cracks. Make sure when performing this test not to break the sample along shrinkage cracks.

Odor Test. Take a small representative sample and heat with an open flame, such as a match or a candle. Check for odor. Organic soils (OL and OH) usually have a distinctive, musty, slightly offensive odor.

Cast Test. A representative portion of the sample is mixed with water until it can be molded or shaped without sticking to the fingers. Compress the soil into a ball or cigar-shaped cast. Observe the ability of the sample to withstand handling without crumbling.

If the cast crumbles when touched, such as when lightly pushed with a finger, the sample is sand with little to no fines (SW or SP).

If the cast withstands careful handling, such as lightly passing the cast back and forth between hands, the sample is sand with an appreciable amount of fines (SM or SC).

If the cast can be handled freely or withstands rough handling, the sample is silt, clay, or an organic.

Roll or Thread Test. This test is performed only on the material passing the No. 40 sieve. A portion of the sample is mixed with water until it can be molded or shaped without sticking to the fingers.

Shape the sample into a ball or an elongated cylinder and roll the prepared soil cylinder (on a flat, nonabsorbent surface) rapidly into a thread approximately 1/8 inch in diameter. The technique is shown in Figure A2.2. If the moist soil rolls into a thread, it is said to have some plasticity. The number of times it can be lumped back together

and rolled into a thread without crumbling is a measure of the degree of plasticity of the soil. Materials that cannot be rolled in this manner are nonplastic or have a very low plasticity.

Figure A2.2. Technique to Perform the Roll or Thread Test.



The results of this test indicate the following:

If the soil can be molded into a ball or cylinder and deformed under very firm finger pressure without crumbling or cracking--High plasticity (CH).

If the soil can be remolded into a ball, but it cracks or crumbles under finger pressure--Medium plasticity (CL).

If the soil cannot be lumped into a ball or cylinder without breaking up--Low plasticity (CL, ML, or MH).

If the soil forms a soft, spongy ball or thread when molded--Organic material (OL or OH), also peat.

If the soil cannot be rolled into a thread at any moisture content--Nonplastic soil (ML or MH).

Note: Micaceous silts and sands may be rolled due to the flaky nature of the mica.

Ribbon Test. This test is also performed only on material passing the No. 40 sieve. A representative portion of the sample is mixed with water until it can be molded or shaped without sticking to the fingers.

Form a roll of soil about 1/2 to 3/4 inch in diameter and 3 to 5 inches long. Lay the roll across the palm of one hand (palm up), and starting at one end, squeeze the roll between the thumb and forefinger over the edge of the hand to form a flat, unbroken ribbon about 1/8 to 1/4 inch thick. Allow the ribbon as formed to hang free and unsupported (Figure A2.3). Continue squeezing and handling the roll carefully to form the maximum length of ribbon that can be supported only by the cohesive properties of the soil.

The results of this test indicate the following:

If the sample holds together for a length of 8 to 10 inches without breaking--Highly plastic and highly compressive (CH).

If the soil can be ribboned only with difficulty into 3-inch to 8-inch lengths--Low plasticity (CL).

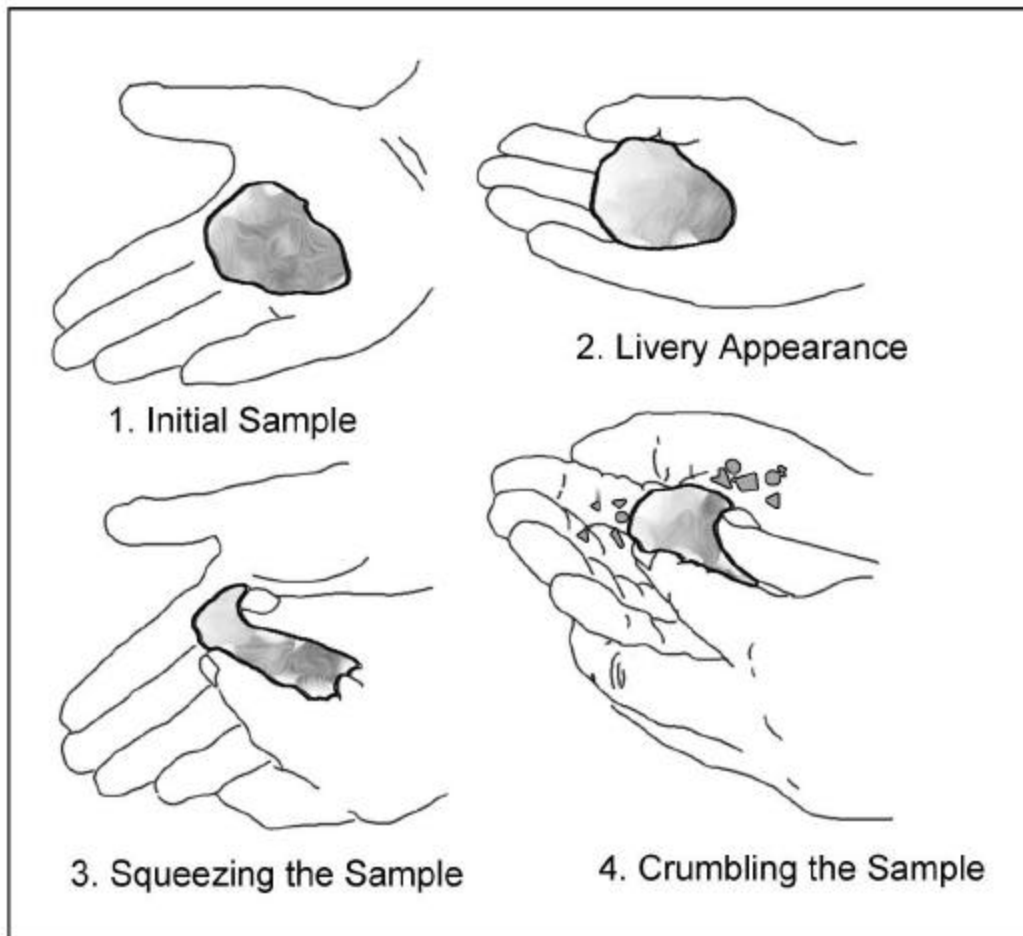
Figure A2.3. Technique to Perform the Ribbon Test.



Wet Shaking Test. This test is performed only on the material passing the No. 40 sieve. A representative portion of the sample, enough material to form a ball of material about 3/4 inch in diameter, is mixed with water until it can be molded or shaped without sticking to the fingers (Figure A2.4, Step 1).

Smooth the soil pat in the palm of the hand with the blade of a knife or small spatula. Shake the hand with the pat horizontally and strike that hand vigorously with the other hand. Check the soil for a reaction where water comes to the surface producing a smooth, shiny appearance; such an appearance is described as livery (Figure A2.4, Step 2). Squeeze the sample between the thumb and forefinger of the other hand. Check to see (Figure A2.4, Step 3) if the surface water quickly disappears, the surface becomes dull, and the material becomes firm, resisting deformation. Continue to apply pressure and check to see if cracks occur and the sample crumbles like a brittle material (Figure A2.4, Step 4).

Figure A2.4. Steps for the Wet Shaking Test.



Very fine sands and silts are readily identified by the wet shaking test. Since it is rare that fine sands and silts occur without some amount of clay mixed with them, there are varying reactions to this test. Even a small amount of clay will tend to greatly retard this reaction when the water comes to the surface. The results of this test indicate the following:

If there is a rapid reaction to the shaking test, then this indicates nonplastic, fine sands and silts.

If there is a sluggish reaction, then this indicates slight plasticity (such as might be found from a test of some organic silts) or silts containing a small amount of clay.

If there is no reaction, this indicates the sample is clayey.

Bite or Grit Test. Place a small pinch of the sample between the teeth and bite. The results of this test indicate the following:

- If the sample feels gritty and grates the teeth, then the sample is sandy.
- If the sample feels only slightly harsh, the sample is silty.
- If the sample feels like flour, that is smooth and powdery, the sample is clayey.

Shine Test. This test is performed only on the material passing the No. 40 sieve. Take a small, slightly moist pat sample and rub a fingernail or a smooth metal surface such as a knife blade across the sample. The results of this test indicate the following:

- If the test produces a definite shine, the material is a highly plastic clay (CH).
- If the sample remains dull, the material is a low compressible clay (CL).
- If the surface remains very dull or appears granular, the sample is a silt or sand.

Wash, Dust, and Smear Test. This test is performed only on the material passing the No. 40 sieve. Take a small, completely dry sample of soil and drop it from a height of 1 to 2 feet above a clean, solid surface.

- If there is a fairly large amount of dust produced, the sample is a silty sand (SM).
- If very little dust is produced, the sample is a clean sand. Check the gradation (SW or SP).

Take a small amount of soil and add water until it is moist but does not stick to the fingers. Smear the sample between the thumb and forefinger.

- If a gritty, harsh feel is produced, the sample contains a small amount of silt. Check the gradation (SW or SP).
- If a rough but less harsh feel is produced, the soil contains about 10 percent silt (SM).

Feel Test. This part of the test is performed only on the material passing the No. 40 sieve. Rub the sample of the soil (i.e., the material passing the No. 40 sieve) between the fingers and observe the texture and describe it as floury, smooth, gritty, or sharp. Then rub the sample on the inside of the wrist. Typical results are:

- Sand will feel gritty.
- Silts, if dry, will dust readily and feel soft and silky to the touch.
- Clays powder only with difficulty, but feel smooth and gritless like flour.

If it is a clay, squeeze a piece of the undisturbed soil (taken and set aside from the location of the original sample) between the thumb and forefinger to determine its consistency. Remold the soil by working it between the hands and observe the results.

- If the sample becomes fluid, it is a clay probably near their liquid limit.
- If the sample remains stiff and crumbles when reworked, it is probably a clay below the plastic limit.

Plasticity Estimation. If additional information is required on the range of plasticity of the soil, run this test. Using a small representative sample of soil, remove all particles coarser than a grain of salt. Mold the remaining particles into a small (about 3/4-inch) cube, adding enough moisture to make the cube the consistency of putty. Air dry the cube. Place the cube between the forefinger and thumb and squeeze to crush it.

- If the cube falls apart easily, the soil is nonplastic; the PI range is 0 to 3.
- If the cube is easily crushed, the soil is slightly plastic; the PI range is 4 to 8.
- If the cube is difficult to crush, the soil is medium plastic; the PI range is 9 to 30.
- If the cube is impossible to crush, the soil is highly plastic; the PI range is 31 or more.

Identification Sequence. Figure A2.5 provides the suggested sequence of tests for identifying and classifying a soil sample using the expedient field classification procedures. **Use the tests that are appropriate to the given soil sample. If a visual examination will define the soil type, only one or two of the other tests may be needed to verify the identification.** Some tests may yield duplicate results. When the results from one set of tests are inconclusive, some of the similar tests can be tried to establish the best identification.

Figure A2.5. Flowchart for Expedient Field Classification Procedures.

